



Architectural *Lighting*

Volume -1 2026-27





Scan this QR Code on
your mobile to
check out the website

Disclaimer : All product visuals in this catalogue are for representation purposes.
Due to continuous product development and lighting conditions, actual products
may vary slightly in appearance, finish, or specifications.



About us

At Biocon, we engineer excellence across every connection. As a trusted manufacturer of led lighting system, wires & cables, switches & accessories, mcbs, switchgear, and our flagship pvc tapes, we deliver solutions that define reliability and performance with 1000+ products manufactured in-house, each piece reflects our commitment to precision, technology, and uncompromising quality. Every product is crafted with care, ensuring durability and superior standards that our customers depend on.

Expanding into architectural lighting, we bring together innovation and design—creating lighting solutions that elevate spaces with elegance and efficiency. Manufactured in our state-of-the-art facility, our products embody the perfect balance of form and function.

At Biocon, we don't just build products—we create experiences powered by innovation, quality, and trust.





Residential

If there is anything that can appreciably alter your lighting experience and feel of your home, it's LED Lighting by Biocon. Bright light for study or reading corners. Warm light for living and dining. Soft light for your kitchen. Set the right moods with Biocon LED lights.



Industrial

Increase energy efficiency with Biocon LED lights. Every Industry needs different lighting infrastructure for proficient working. Hence the need for good quality and uniform lighting for its various needs like shop floor, warehouse, quality labs, stores, bay areas, workplace.



Outdoor

Make public areas safer with Biocon LED Lights. Durable lights for Long term maintenance free use clear, high contrast light for night-time visibility. Choose from the wide range of our products to suit your different needs.



Commercial

To utilise energy in an efficient manner and to improve productivity, there is a need of distinct LED lighting solutions for Commercials buildings, Healthcare segments, Educational facilities, Hotels and Resorts, Bay areas and Workplace. Warm lighting for its reception, versatile lighting for board room and any other area you choose to illuminate.

TERMS & CONDITIONS

1. Rates are subject to change without prior notice.
2. All taxes are extra as applicable.
3. Goods will be supplied according to stock position.
4. Subject to Delhi Jurisdiction only.
5. Warranty against manufacturing defects only.
6. All wattage may be differ \pm 8-10% based on heating capacity.
7. Warranty : The company will diligently adhere to 2 years warranty term for all of its products.

*Architectural
Brilliance in Every Beam*



TECHNOLOGY PARTNERS



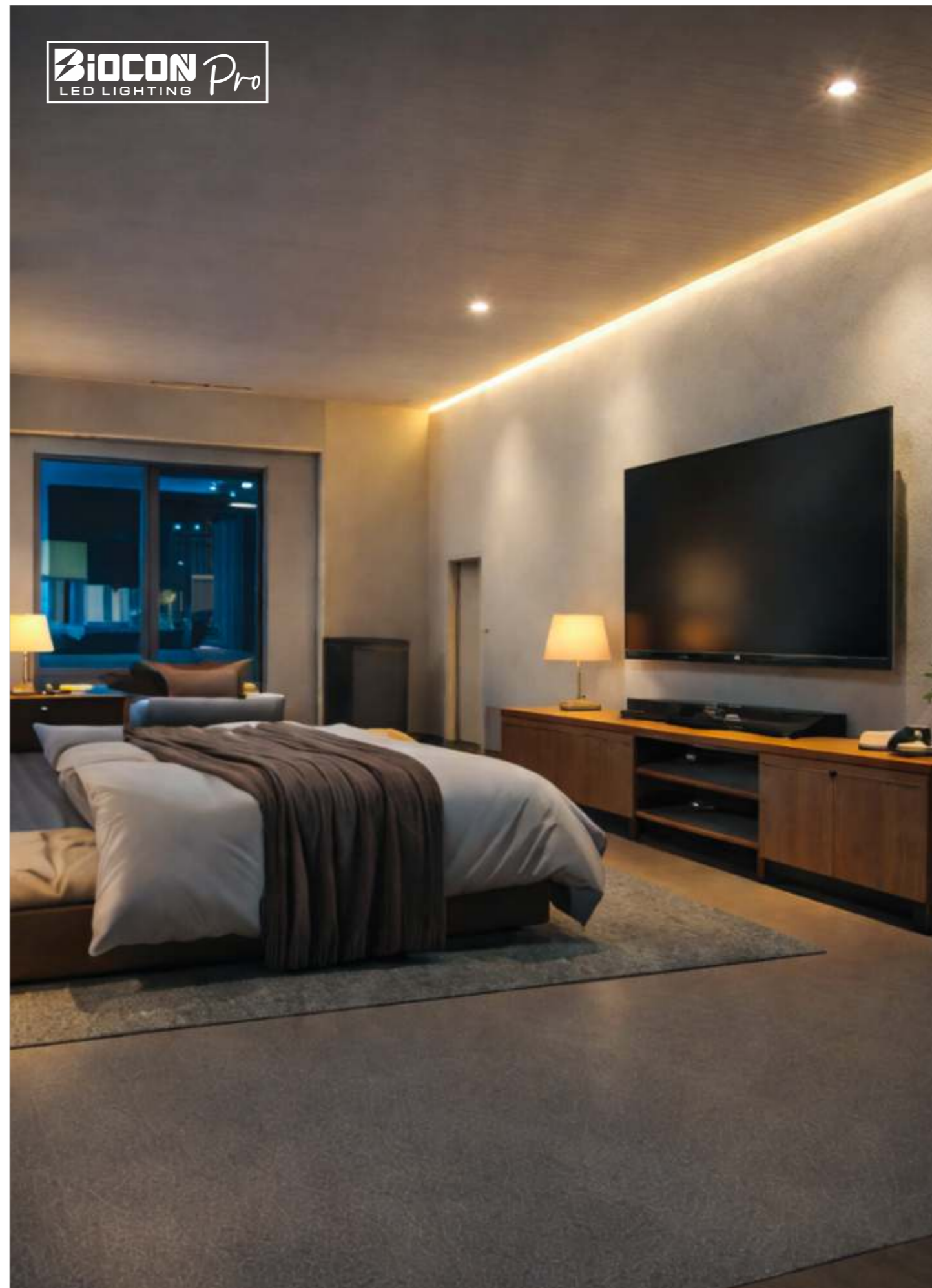

BIOCON Pro
LED LIGHTING



Info@bioconelectric.in | www.bioconelectric.com



Info@bioconelectric.in | www.bioconelectric.com



Info@bioconelectric.in | www.bioconelectric.com



Info@bioconelectric.in | www.bioconelectric.com



Info@bioconelectric.in | www.bioconelectric.com



Info@bioconelectric.in | www.bioconelectric.com



Info@bioconelectric.in | www.bioconelectric.com



Info@bioconelectric.in | www.bioconelectric.com



Original Type



Blackhole Type

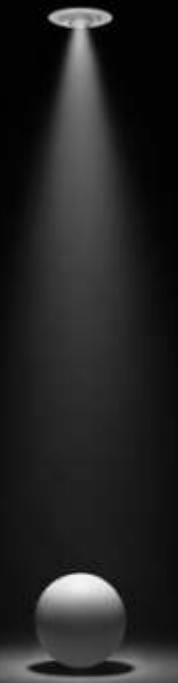

Snout Type

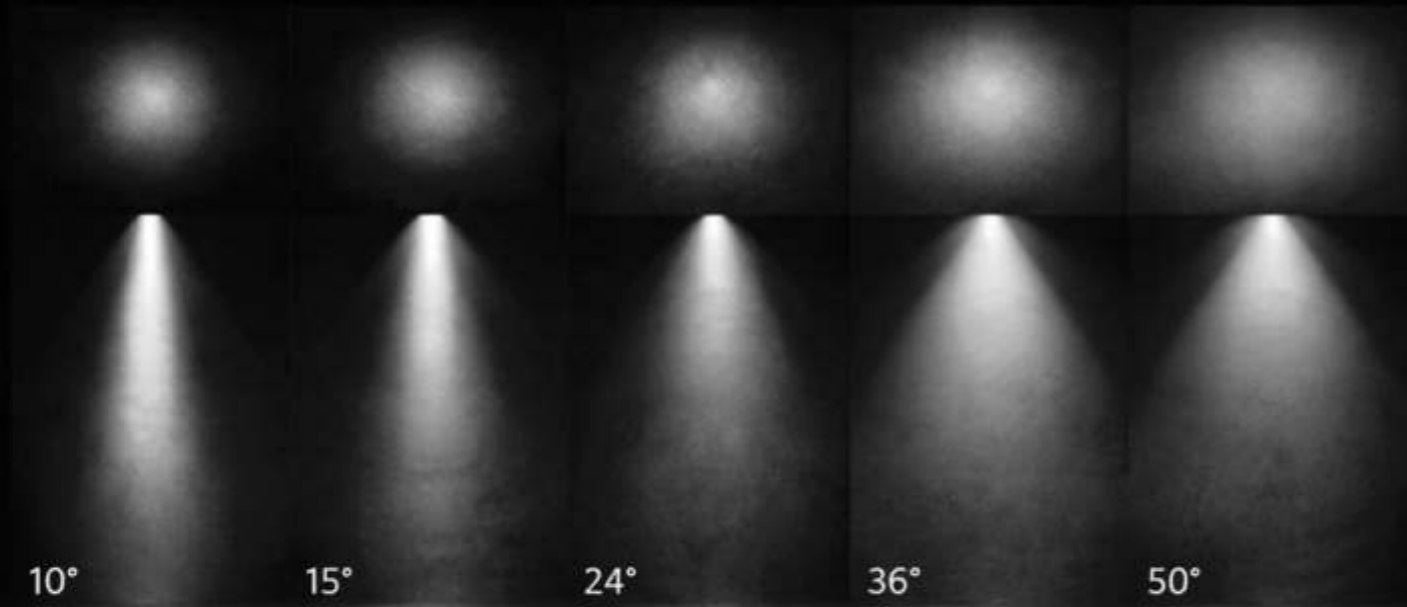

10°

15°

24°

36°

50°



Acrylic Type



Focusing Type



Reflector Type



Acrylic Type



Focusing Type



Reflector Type

COB DOWNLIGHTS

BIOCON Pro
LED LIGHTING





TITAN LED
RECESSED DOWNLIGHT

BIOCON Pro
LED LIGHTING



TITAN LED

RECESSED DOWNLIGHT



PRODUCT FEATURES AND BENEFIT

- > Slim Recessed Design – Blends seamlessly into modern ceilings.
- > Uniform Light Output – Provides smooth and glare-free illumination.
- > Energy Efficient LED – High brightness with low power consumption.
- > Wide Beam Spread – Ensures even lighting across the space.
- > Premium Finish Ring – Elegant trim enhances interior aesthetics.
- > Long Lifespan – Reliable performance with minimal maintenance.

PRODUCT DIMENSION

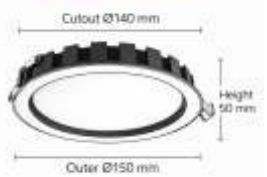

BEAM ANGLE



 Recessed Mount	 Operating Voltage 110-300V AC	 Aluminium Housing	 Surge Protection Upto 4KV	 Focused Halogen Effect	 3IN1 Mood Lighting
--	---	---	---	--	--

Technical Details

Item Code	TDLPWH2012WWN	TDLPWH2018WWN
Wattage	12W	18W
Length	120mm	150mm
Cutout	110mm	140mm
Height	50mm	50mm
PKG.	40 Pcs.	40 Pcs.
Price ₹	800.00	1125.00

Led Type : SMD
LM/W : 100LM/W
CCT : 3000+4000+6500K

Beam Angle : 120°
CRI : 91
Body Colour : BLK/WH

Voltage : AC110~300V
Current : 280-300mA

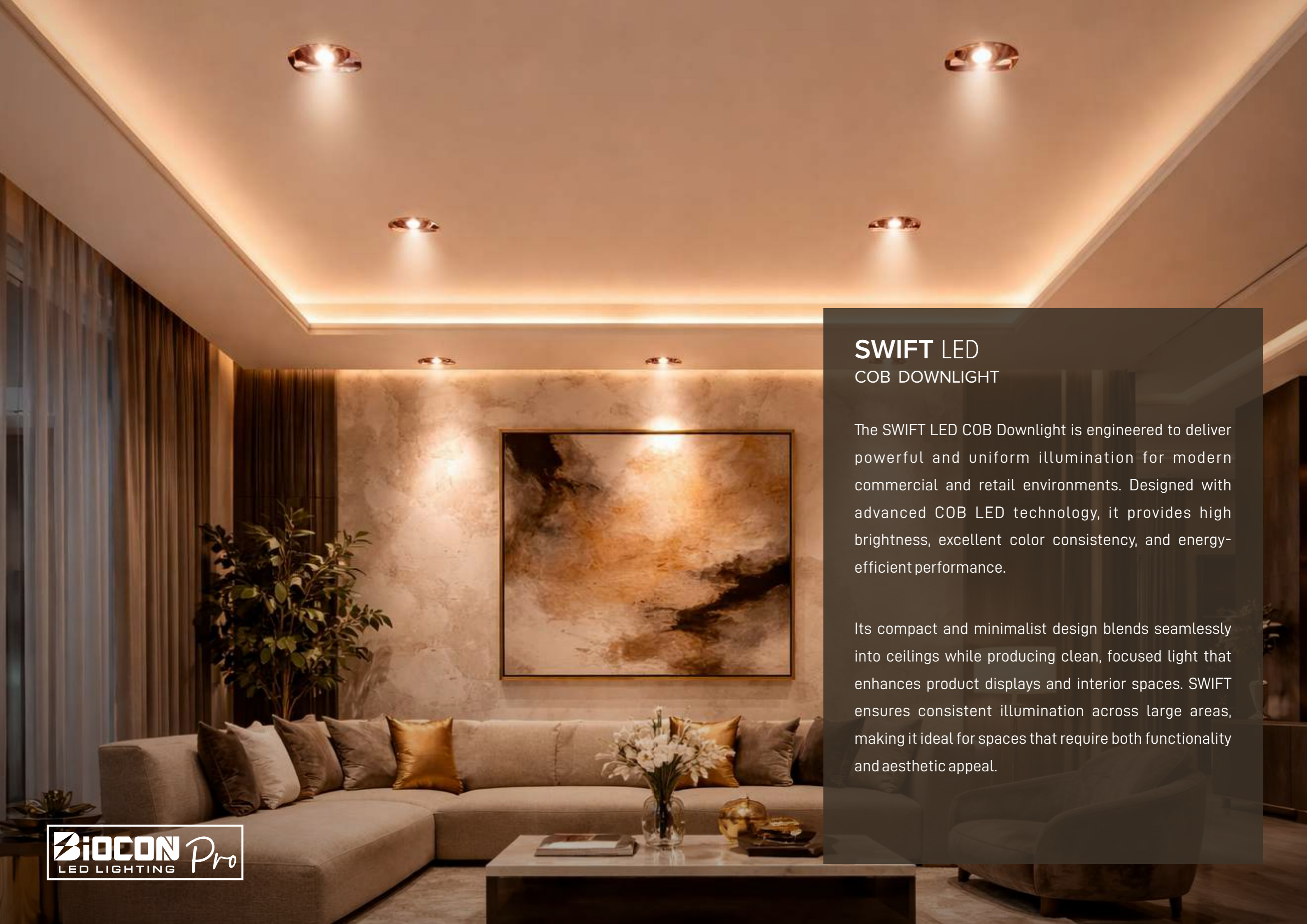

SWIFT LED COB DOWNLIGHT

The SWIFT LED COB Downlight is engineered to deliver powerful and uniform illumination for modern commercial and retail environments. Designed with advanced COB LED technology, it provides high brightness, excellent color consistency, and energy-efficient performance.

Its compact and minimalist design blends seamlessly into ceilings while producing clean, focused light that enhances product displays and interior spaces. SWIFT ensures consistent illumination across large areas, making it ideal for spaces that require both functionality and aesthetic appeal.



SWIFT LED

COB DOWNLIGHT



PRODUCT FEATURES AND BENEFIT

- > Precision COB light engine for sharp and consistent beam output
- > High-reflective cone reflector for enhanced light projection
- > Advanced thermal management with aluminium heat sink body
- > Uniform beam spread for balanced illumination across spaces
- > Low glare optical design for comfortable visual experience
- > Optimized lumen efficiency for maximum light with less power
- > Engineered for commercial lighting environments

PRODUCT DIMENSION

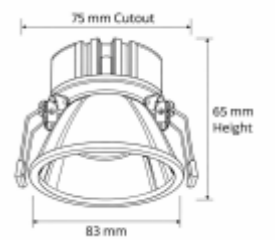

BEAM ANGLE



Recessed Mount	Operating Voltage 110-300V AC	Aluminium Housing	Surge Protection Upto 4KV	Focused Halogen Effect	3IN1 Mood Lighting
----------------	----------------------------------	-------------------	------------------------------	---------------------------	-----------------------

Technical Details

Item Code	SDLPGBK2612WWN
Wattage	12W
Length	83mm
Cutout	75mm
Height	65mm
PKG.	40 Pcs.
Price ₹	1250.00

Led Type : COB
LM/W : 100LM/W
CCT : 3000+4000+6500K

Beam Angle : 36°
CRI : 91
Body Colour : BLK+GB/BLK+RG

Voltage : AC110~300V
Current : 280-300mA

BRONZA COB MOVABLE DOWNLIGHT

The BRONZA COB Tilttable Downlight is designed to deliver focused and adjustable illumination for modern interior spaces. Its precision tilting mechanism allows the light beam to be directed exactly where it is needed, making it ideal for highlighting artwork, walls, and architectural details.

Equipped with advanced COB LED technology, BRONZA ensures powerful illumination, excellent color consistency, and energy-efficient performance. The sleek and minimal design blends seamlessly with contemporary interiors while providing professional-grade lighting control.



BRONZA COB
MOVABLE DOWNLIGHT





BRONZA COB

MOVABLE DOWNLIGHT



PRODUCT FEATURES AND BENEFIT

- > Tiltable design for adjustable and precise light direction
- > High-efficiency COB LED for powerful and uniform illumination
- > Premium aluminium heat sink for superior heat dissipation
- > Deep reflector design for focused and glare-controlled lighting
- > Energy-efficient LED technology for low power consumption
- > Ideal for accent and highlight lighting in interiors
- > Perfect for showrooms, galleries, hotels, and retail spaces

PRODUCT DIMENSION

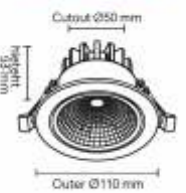

BEAM ANGLE



 Recessed Mount	 Operating Voltage 110-300V AC	 Aluminium Housing	 Surge Protection Upto 4KV	 Tilttable Focused Illumination	 3IN1 Mood Lighting
--	---	---	---	--	--

Technical Details

Item Code	BDLP2116WWN	BDLP2130WWN
Wattage	16W	30W
Length	110mm	145mm
Cutout	50mm	65mm
Height	53mm	68mm
PKG.	30 Pcs.	20 Pcs.
Price ₹	1500.00	2300.00

Led Type : COB
LM/W : 100LM/W
CCT : 3000+4000+6500K

Beam Angle : 36°
CRI : 91

Voltage : AC110~300V
Current : 280-300mA



OZZO 3in1
DEEP DOWNLIGHT COLOUR CHANGEABLE

BIOCON Pro
LED LIGHTING



OZZO 3in1

DEEP DOWNLIGHT COLOUR CHANGEABLE



PRODUCT FEATURES AND BENEFIT

- > High-efficiency LED recessed downlight for modern architectural lighting
- > Precision 120° beam angle for focused illumination
- > Deep-set diffuser design for glare-free lighting output
- > High-quality aluminium body for better heat dissipation
- > Advanced heat sink design ensures longer lifespan
- > Uniform light distribution with soft edge beam spread
- > Ideal for accent lighting & highlighting applications

BEAM ANGLE



Beam Angle 120°



Recessed Mount



Operating Voltage
110-300V AC



Aluminium Housing



Surge Protection
Upto 4KV



3IN1 Mood Lighting

Technical Details

Item Code	ODDL4612WWN1W	ODDL4618WWN1W
Wattage	12W	18W
Cutout	101mm	152mm
PKG.	40 Pcs.	20 Pcs.
Price ₹	850.00	1200.00

Led Type : SMD
LM/W : 100LM/W
CCT : 3000+4000+6500K

Beam Angle : 120°
CRI : 91

Voltage : AC110~300V
Current : 280-300mA



ION LED
DEEP DOWNLIGHT

BIOCON Pro
LED LIGHTING



ION LED

DEEP DOWNLIGHT



PRODUCT FEATURES AND BENEFIT

- > Deep recessed design for excellent anti-glare performance.
- > High-efficiency LED module delivers bright and uniform lighting.
- > Premium aluminium housing for superior heat dissipation.
- > Precision reflector optics for focused and controlled beam angle.
- > Energy-efficient operation with high lumen output.
- > Compact recessed installation for clean ceiling aesthetics.
- > Long lifespan LED source ensuring reliable performance.
- > Perfect for showrooms, galleries, hotels, and luxury interiors.

PRODUCT DIMENSION

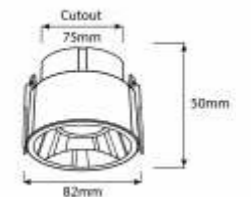

BEAM ANGLE



Recessed Mount |
 Operating Voltage 110-300V AC |
 Aluminium Housing |
 Surge Protection Upto 4KV |
 Focused Halogen Effect |
 3IN1 Mood Lighting

Technical Details

Item Code	IDLPGBK2208WWN	IDLPGBK2215WWN	IDLPGBK2220WWN
Wattage	8W	15W	20W
Length	75mm	82mm	95mm
Cutout	60mm	75mm	85mm
Height	45mm	50mm	60mm
PKG.	40 Pcs.	30 Pcs.	30 Pcs.
Price ₹	1125.00	1475.00	2100.00

Led Type : SMD
 LM/W : 100LM/W
 CCT : 3000+4000+6500K

Beam Angle : 36°
 CRI : 91
 Body Colour : BLK+GB

Voltage : AC110~300V
 Current : 280-300mA



AERO COB
LED DOWNLIGHT

BIOCON Pro
LED LIGHTING

AERO COB

LED DOWNLIGHT



PRODUCT FEATURES AND BENEFIT

- > High-intensity COB LED delivers powerful and focused illumination.
- > Deep reflector design ensures low glare and visual comfort.
- > Die-cast aluminium heat sink for superior thermal management.
- > High lumen efficiency with reduced power consumption.
- > Recessed ceiling mount for a clean and modern lighting look.
- > Spring-clip installation for quick and secure fitting.
- > Long life LED source for reliable and maintenance-free operation.
- > Ideal for showrooms, retail stores, hotels, and premium interiors.

PRODUCT DIMENSION

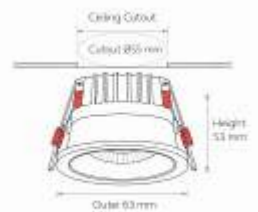

BEAM ANGLE



- Recessed Mount
- Operating Voltage 110-300V AC
- Aluminium Housing
- Surge Protection Upto 4KV
- Focused Halogen Effect

Technical Details

Item Code	ADLPGW2307WH	ADLPGW2312WH	ADLPGW2318WH
Wattage	7W	12W	18W
Length	63mm	83mm	95mm
Cutout	55mm	75mm	80mm
Height	53mm	65mm	74mm
PKG.	50 Pcs.	40 Pcs.	30 Pcs.
Price ₹	570.00	725.00	1000.00

Led Type : COB
LM/W : 100LM/W
CCT : 3000/4000/6500K

Beam Angle : 36°
CRI : 91
Body Colour : WH/BLK

Voltage : AC110~300V
Current : 280-300mA



GLEON LED
COB DOWNLIGHT

BIOCON Pro
LED LIGHTING



GLEON LED

COB DOWNLIGHT



PRODUCT FEATURES AND BENEFIT

- > High-lumen COB LED module for powerful spotlight illumination
- > Copper-finish reflector for enhanced light efficiency and aesthetics
- > Robust aluminium heat sink for superior thermal performance
- > Deep-set optical chamber for reduced glare output
- > Precision beam control for focused accent lighting
- > Designed for premium commercial lighting environments
- > Ideal for galleries, boutiques, hotels, and luxury retail

PRODUCT DIMENSION

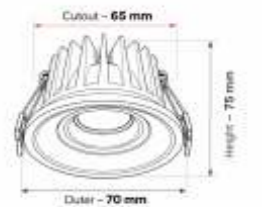

BEAM ANGLE



- Recessed Mount
- Operating Voltage 110-300V AC
- Aluminium Housing
- Surge Protection Upto 4KV
- Focused Halogen Effect

Technical Details

Item Code	GDLPBKRG2707WH	GDLPBKRG2712WH	GDLPBKRG2718WH
Wattage	7W	12W	18W
Length	70mm	83mm	95mm
Cutout	65mm	75mm	85mm
Height	75mm	65mm	75mm
PKG.	50 Pcs.	40 Pcs.	30 Pcs.
Price ₹	600.00	775.00	1100.00

Led Type : COB
LM/W : 100LM/W
CCT : 3000/4000K

Beam Angle : 36°
CRI : 91
Body Colour : BLK+RG/WH+RG

Voltage : AC110~300V
Current : 280~300mA



BELLA LED
COB DOWNLIGHT

BIOCON Pro
LED LIGHTING



BELLA LED COB DOWNLIGHT

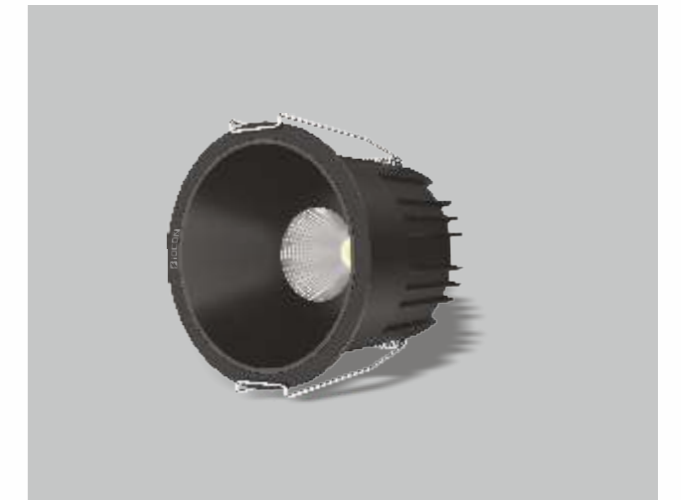





PRODUCT FEATURES AND BENEFIT

- > High-performance COB LED technology for intense, focused illumination
- > Deep reflector design for low glare and visual comfort
- > Precision beam control for accent and spotlight applications
- > Recessed mounting for seamless ceiling integration
- > High lumen output with excellent energy efficiency
- > Superior color rendering for true color visibility
- > Durable aluminium housing with efficient heat dissipation

BEAM ANGLE



Beam Angle 36°

 Recessed Mount	 Operating Voltage 110-300V AC	 Aluminium Housing	 Surge Protection Upto 4KV	 Focused Halogen Effect
---	---	--	---	---

Technical Details

Item Code	BDLRBK4207WH	BDLRBK4212WH	BDLRBK4218WH
Wattage	7W	12W	18W
Cutout	55 MM	75 MM	95 MM
PKG.	40 Pcs.	30 Pcs.	20 Pcs.
Price ₹	700.00	900.00	1250.00

Led Type : COB
LM/W : 100LM/W
CCT : 3000/4000/6500K

Beam Angle : 24-36°
CRI : 92

Voltage : AC110~300V
Current : 280-300mA



BELLA 3in1

COB DOWNLIGHT COLOUR CHANGEABLE



PRODUCT FEATURES AND BENEFIT

- > High-performance COB LED technology for intense, focused illumination
- > Deep reflector design for low glare and visual comfort
- > Precision beam control for accent and spotlight applications
- > Recessed mounting for seamless ceiling integration
- > High lumen output with excellent energy efficiency
- > Superior color rendering for true color visibility
- > Durable aluminium housing with efficient heat dissipation

BEAM ANGLE



Beam Angle 36°

 Recessed Mount	 Operating Voltage 110-300V AC	 Aluminium Housing	 Surge Protection Upto 4KV	 Focused Halogen Effect	 3IN1 Mood Lighting
--	---	---	---	--	--

Technical Details

Item Code	BDLRBK5007WWN	BDLRBK5012WWN	BDLRBK5018WWN
Wattage	7W	12W	18W
Cutout	55 MM	75 MM	95 MM
PKG.	40 Pcs.	30 Pcs.	20 Pcs.
Price ₹	700.00	900.00	1250.00

Led Type : COB
LM/W : 100LM/W
CCT : 3000/4000/6500K

Beam Angle : 24-36°
CRI : 92

Voltage : AC110~300V
Current : 280-300mA

ONYX COB LINEAR LIGHT SQUARE CUP

The ONYX Façade Light is designed to highlight architectural structures with precision and elegance. Its sleek linear design delivers uniform illumination that enhances building textures, edges, and surfaces, creating a striking visual impact.

Perfect for modern façades, exterior walls, commercial buildings, hotels, and luxury residences, ONYX provides refined lighting that emphasizes architectural depth and form while maintaining a clean, contemporary appearance.

ONYX COB
LINEAR LIGHT SQUARE CUP





ONYX COB

LINEAR LIGHT SQUARE CUP

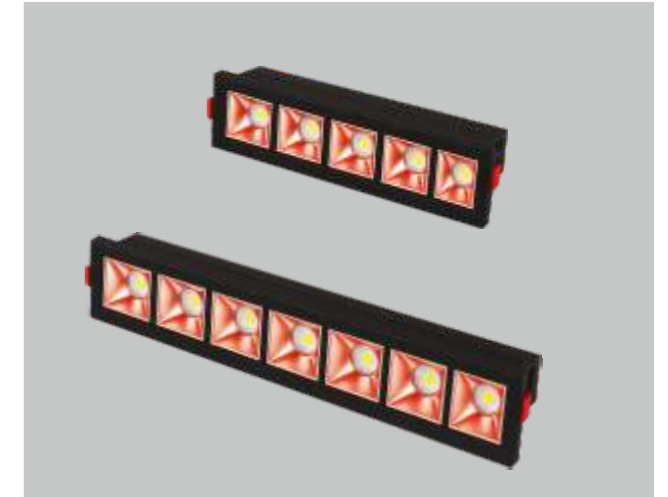

PRODUCT FEATURES AND BENEFIT

- > Multi-head linear design for powerful directional lighting
- > Premium aluminium housing for durability and heat dissipation
- > High-efficiency LED modules for bright and focused illumination
- > Energy-efficient lighting with low power consumption
- > Ideal for showrooms, galleries, and retail displays
- > Focused beam optics for highlighting products and artwork
- > Modern slim profile for clean architectural aesthetics
- > Uniform light distribution across multiple light sources

PRODUCT DIMENSION

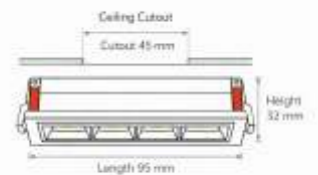

BEAM ANGLE

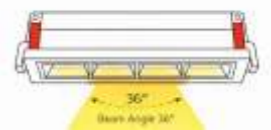

- Recessed Mount
- Operating Voltage 110-310V AC
- Aluminium Housing
- Surge Protection Upto 4KV
- Focused Beam Effect

Technical Details

Item Code	OLLPBKRG2006WH	OLLPBKRG2012WH
Wattage	6W	12W
Length	95mm	148mm
Cutout	45mm	45mm
Height	32mm	32mm
PKG.	50 Pcs.	20 Pcs.
Price ₹	690.00	900.00

Led Type : COB
LM/W : 100LM/W
CCT : 3000/4000K

Beam Angle : 36°
CRI : 91
Body Colour : BLK+RG Sq. CUP

Voltage : AC110~300V
Current : 280-300mA

NEXO DUAL-HEAD ADJUSTABLE LED DOWNLIGHT

The NEXO LED Adjustable Downlight is designed to provide precise and flexible illumination for modern commercial and retail spaces. With its adjustable tilt mechanism, the light can be directed exactly where it is needed, making it ideal for highlighting products, displays, and architectural features.

Engineered with advanced LED technology, NEXO delivers bright, energy-efficient illumination with excellent color consistency, enhancing the visibility and appeal of showcased items. Its sleek recessed design blends seamlessly into ceilings while maintaining a clean and contemporary look.





NEXO DUAL-HEAD

ADJUSTABLE LED DOWNLIGHT



PRODUCT FEATURES AND BENEFIT

- > Retractable spotlight head for flexible directional lighting
- > Dual-head design for wider lighting coverage
- > High-efficiency LED module for bright focused illumination
- > Premium aluminium body for durability and heat dissipation
- > Adjustable beam direction for precise accent lighting
- > Ideal for retail stores, galleries, and commercial interiors
- > Recessed ceiling installation for clean architectural appearance

PRODUCT DIMENSION

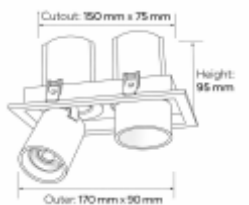

BEAM ANGLE



Recessed Mount |
 Operating Voltage 110-300V AC |
 Aluminium Housing |
 Surge Protection Upto 4KV |
 Tilttable Focused Illumination |
 3IN1 Mood Lighting

Technical Details

Item Code	NDLPWH3124WWN
Wattage	2X12W
Length	170*90mm
Cutout	150*75mm
Height	95mm
PKG.	20 Pcs.
Price ₹	3600.00

Led Type : COB
 LM/W : 100LM/W
 CCT : 3000+4000+6500K

Beam Angle : 36°
 CRI : 91
 Body Colour : WH

Voltage : AC110~300V
 Current : 280-300mA



NEXO LED
RETRACTABLE DIMMABLE SPOT LIGHT

BIOCON Pro
LED LIGHTING

NEXO LED
RETRACTABLE DIMMABLE SPOT LIGHT





NEXO LED

RETRACTABLE DIMMABLE SPOT LIGHT



PRODUCT FEATURES AND BENEFIT

- > Retractable spotlight head for adjustable lighting direction
- > Dimmable LED function for customizable brightness control
- > High-efficiency LED module for focused illumination
- > Smooth tilt and rotation for precise light positioning
- > Premium aluminium housing for durability and heat dissipation
- > Ideal for accent lighting in showrooms, galleries, spas, luxury homes
- > Low glare optical design for comfortable lighting output
- > Recessed ceiling installation for clean architectural aesthetics

PRODUCT DIMENSION



BEAM ANGLE



 Recessed Mount	 Operating Voltage 110-300V AC	 Aluminium Housing	 Surge Protection Upto 4KV	 Tilttable Focused Illumination	 3IN1 Mood Lighting
--	---	---	---	--	--

Technical Details

Item Code	NDLPWH3212WWN
Wattage	12W
Length	90mm
Cutout	75mm
Height	75mm
PKG.	40 Pcs.
Price ₹	1750.00

Led Type : COB
LM/W : 100LM/W
CCT : 3000+4000+6500K

Beam Angle : 36°
CRI : 91
Body Colour : WH

Voltage : AC110~300V
Current : 280-300mA



LUXX COB
LED SPOT LIGHT

BIOCON Pro
LED LIGHTING

LUXX COB
LED SPOT LIGHT



LUXX COB

LED SPOT LIGHT



PRODUCT FEATURES AND BENEFIT

- > High-performance COB LED for powerful focused illumination
- > Deep reflector design for glare-controlled lighting
- > Premium aluminium heat sink for efficient heat dissipation
- > Energy-efficient LED technology for reduced power consumption
- > Compact spotlight design for precise accent lighting
- > Ideal for wardrobes, shelves, jewelry cabinet
- > High-intensity beam for highlighting products and artwork

PRODUCT DIMENSION

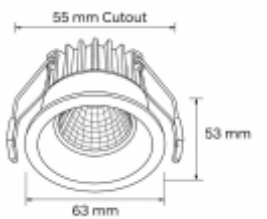

BEAM ANGLE

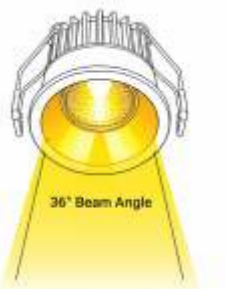

- Recessed Mount
- Operating Voltage 110-300V AC
- Aluminium Housing
- Surge Protection Upto 4KV
- Focused Halogen Effect

Technical Details

Item Code	LDLPRG2407WH	LDLPRG2412WH
Wattage	7W	12W
Length	63mm	83mm
Cutout	55mm	75mm
Height	53mm	65mm
PKG.	50 Pcs.	40 Pcs.
Price ₹	625.00	800.00

Led Type : DOB
LM/W : 100LM/W
CCT : 3000K

Beam Angle : 36°
CRI : 91
Body Colour : BLK+RG

Voltage : AC110~300V
Current : 280-300mA

QUARTZ LED SPOT DOWNLIGHT

The QUARTZ LED Spot Downlight is designed to deliver highly focused illumination for premium display environments. With its precise beam control, it enhances the brilliance, sparkle, and true color of showcased products, making it ideal for high-end retail spaces.

Engineered with advanced LED technology, QUARTZ provides sharp accent lighting with excellent color rendering, ensuring that jewellery, watches, and luxury items appear vibrant and visually appealing.

QUARTZ LED

SPOT DOWNLIGHT



PRODUCT FEATURES AND BENEFIT

- > Focused Spot Lighting – Ideal for highlighting shelves and cabinets.
- > Deep Anti-Glare Reflector – Provides comfortable and controlled light.
- > High-Efficiency LED – Bright illumination with low power consumption.
- > Premium Aluminium Housing – Durable body with excellent heat dissipation.
- > Clean Recessed Installation – Blends seamlessly into ceilings and panels.
- > Perfect for Display Lighting – Suitable for wardrobes, shelves, and cabinets.

PRODUCT DIMENSION

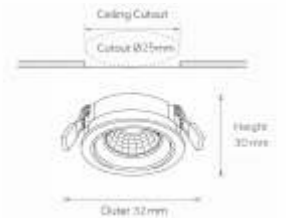

BEAM ANGLE

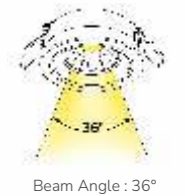

Recessed Mount



Operating Voltage
110-300V AC



Aluminium
Housing



Surge Protection
Upto 4KV



Focused
Halogen Effect

Technical Details

Item Code	QDLPWH2403WH
Wattage	3W
Length	32mm
Cutout	25mm
Height	30mm
PKG.	100 Pcs.
Price ₹	275.00

Led Type : DOB
LM/W : 100LM/W
CCT : 3000K

Beam Angle : 36°
CRI : 91
Body Colour : BLK+RG/WH+RG

Voltage : AC110~300V
Current : 280-300mA

IVORY LED SPOT LIGHT

The IVORY LED Spot Light is designed to deliver precise and elegant accent lighting for modern interiors. With its focused beam and compact design, it highlights décor elements, shelves, artwork, and architectural details while creating a warm and inviting atmosphere.

Engineered with advanced LED technology, IVORY provides energy-efficient performance, consistent illumination, and long-lasting reliability. Its minimal design blends seamlessly into ceilings, making it perfect for both decorative and functional lighting.





IVORY LED SPOT LIGHT



PRODUCT FEATURES AND BENEFIT

- > Compact spotlight design for precise directional lighting
- > High-intensity LED output for sharp focused illumination
- > Ribbed aluminium body for effective heat management
- > Narrow beam projection for highlighting specific objects
- > Low glare optical structure for comfortable lighting
- > Ideal for display cabinets, niches, and feature walls
- > Perfect for retail displays, galleries, and premium interiors
- > Minimal recessed footprint for clean architectural integration

PRODUCT DIMENSION

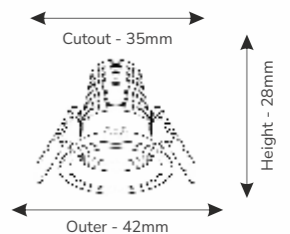

BEAM ANGLE



- Recessed Mount
- Operating Voltage 110-300V AC
- Aluminium Housing
- Surge Protection Upto 4KV
- Focused Halogen Effect

Technical Details

Item Code	IDLPBK2803WH
Wattage	3W
Length	42mm
Cutout	35mm
Height	28mm
PKG.	100 Pcs.
Price ₹	550.00

Led Type : DOB
LM/W : 100LM/W
CCT : 3000K

Beam Angle : 36°
CRI : 91
Body Colour : BLK

Voltage : AC110~300V
Current : 280-300mA



BLITZ LED
SPOT LIGHT

BIOCON Pro
LED LIGHTING



BLITZ LED

SPOT LIGHT

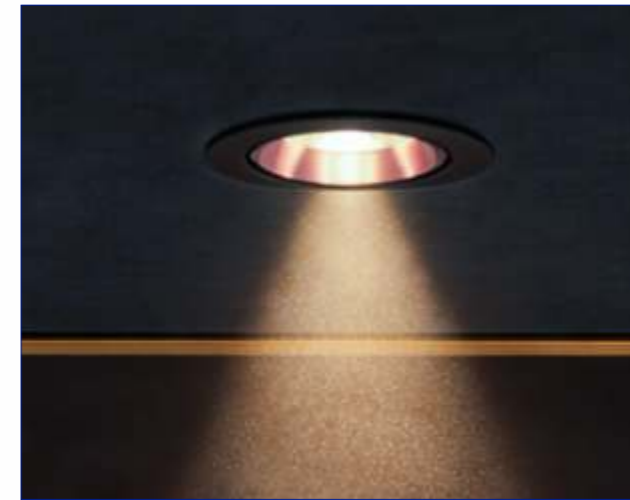

PRODUCT FEATURES AND BENEFIT

- > Compact spotlight for precise accent lighting
- > High-efficiency LED chip for bright focused output
- > Deep reflector optics for controlled beam projection
- > Premium aluminium body for durability and heat dissipation
- > Low power consumption for energy-saving operation
- > Ideal for display cabinets, niches, and artwork lighting
- > Minimal recessed design for clean ceiling integration

PRODUCT DIMENSION



BEAM ANGLE



 Recessed Mount	 Operating Voltage 110-300V AC	 Aluminium Housing	 Surge Protection Upto 4KV	 Focused Halogen Effect
--	---	---	---	--

Technical Details

Item Code	BDLPBKR2901WH
Wattage	1W
Length	32mm
Cutout	25mm
Height	30mm
PKG.	100 Pcs.
Price ₹	230.00

Led Type : DOB
LM/W : 100LM/W
CCT : 3000K

Beam Angle : 36°
CRI : 91
Body Colour : BLK+RG

Voltage : AC110~300V
Current : 280-300mA

NOVA LED
SPOT LIGHT





NOVA LED

SPOT LIGHT



PRODUCT FEATURES AND BENEFIT



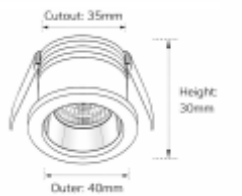

- > Ultra-compact spotlight for subtle accent lighting
- > High-efficiency LED chip for precise focused illumination
- > Deep anti-glare reflector for comfortable visual output
- > Premium aluminium construction for effective heat dissipation
- > Low energy consumption for efficient lighting performance
- > Ideal for display shelves, cabinets, and decorative niches
- > Minimal recessed profile for seamless ceiling integration
- > Stable and flicker-free light output

PRODUCT DIMENSION



BEAM ANGLE



 Recessed Mount	 Operating Voltage 110-300V AC	 Aluminium Housing	 Surge Protection Upto 4KV	 Focused Halogen Effect
--	---	---	---	--

Technical Details

Item Code	NDLPBK3003WH
Wattage	3W
Length	40mm
Cutout	35mm
Height	30mm
PKG.	100 Pcs.
Price ₹	250.00

Led Type : DOB
LM/W : 100LM/W
CCT : 3000K

Beam Angle : 36°
CRI : 91
Body Colour : BLK

Voltage : AC110~300V
Current : 280-300mA



B-TURN LED
DETACHABLE BATTEN SURFACE LIGHT

BIOCON Pro
LED LIGHTING



B-TURN LED

DETACHABLE BATTEN SURFACE LIGHT



PRODUCT FEATURES AND BENEFIT

- > Innovative twist & turn mechanism for adjustable light direction
- > Surface-mounted design for easy installation without cutout
- > Wide-angle illumination with uniform light spread
- > Sleek, ultra-slim profile for modern interiors
- > Smooth rotation for flexible lighting control
- > Glare-free diffuser for comfortable visual experience
- > High-efficiency LED for energy-saving performance

BEAM ANGLE



Beam Angle 120°



Surface Mount



Operating Voltage
110-300V AC



Surge Protection
Upto 4KV



Twist
Function

Technical Details

Item Code	BTDSFLR3808WH	BTDSFLR3812WH	BTDSFLR3818WH	BTDSFLR3824WH
Wattage	8W	12W	18W	24W
Size	120 mm	140 mm	140 mm	140 mm
PKG.	50 Pcs.	40 Pcs.	30 Pcs.	20 Pcs.
Price ₹	325.00	440.00	575.00	1000.00

Led Type : DOB
LM/W : 100LM/W
CCT : 3000/4000/6500K

Beam Angle : 120°
CRI : 80

Voltage : AC110~300V
Current : 280-300mA



B-TURN 3in1

DETACHABLE BATTEN SURFACE LIGHT



PRODUCT FEATURES AND BENEFIT

- > Innovative twist & turn mechanism for adjustable light direction
- > Surface-mounted design for easy installation without cutout
- > Wide-angle illumination with uniform light spread
- > Sleek, ultra-slim profile for modern interiors
- > Smooth rotation for flexible lighting control
- > Glare-free diffuser for comfortable visual experience
- > High-efficiency LED for energy-saving performance

BEAM ANGLE



Beam Angle 120°



Surface Mount



Operating Voltage
110-300V AC



Surge Protection
Upto 4KV



Twist
Function

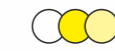

3IN1 Mood
Lighting

Technical Details

Item Code	BTDSFLR3808WWN	BTDSFLR3812WWN	BTDSFLR3818WWN	BTDSFLR3824WWN
Wattage	8W	12W	18W	24W
Size	120 mm	120 mm	120 mm	140 mm
PKG.	50 Pcs.	40 Pcs.	30 Pcs.	20 Pcs.
Price ₹	525.00	675.00	775.00	1200.00

Led Type : DOB
LM/W : 100LM/W
CCT : 3000+4000+6500K

Beam Angle : 120°
CRI : 80

Voltage : AC110~300V
Current : 280-300mA

ZIRCO SPOT

ROTATING SURFACE CYLINDER

The ZIRCO Movable Surface Cylinder is designed to deliver precise directional lighting with a modern architectural aesthetic. Its adjustable head allows the light beam to be easily directed, making it ideal for highlighting specific areas, objects, or architectural details.

With its sleek cylindrical form and contemporary finish, ZIRCO blends seamlessly into modern interiors while providing powerful and focused illumination. The movable design offers flexibility in lighting layouts, allowing spaces to be illuminated exactly as required.





ZIRCO SPOT

ROTATING SURFACE CYLINDER

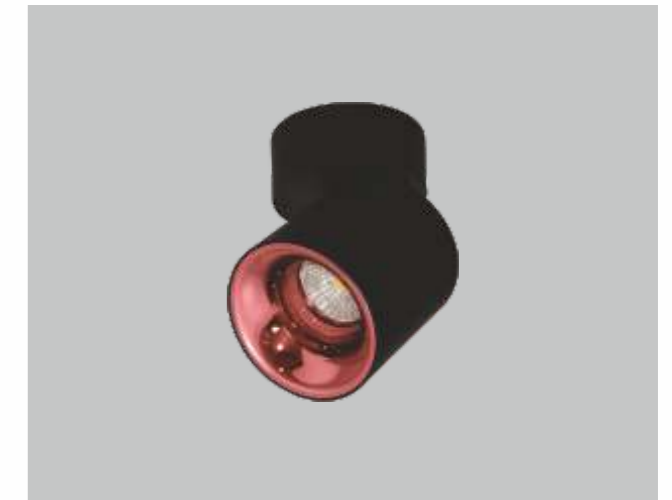

PRODUCT FEATURES AND BENEFIT

- > Tiltable spotlight head for flexible light direction
- > Premium aluminium body for durability and heat control
- > Deep reflector optics for sharp focused beam
- > High-efficiency LED module for bright accent lighting
- > Compact architectural design for modern interiors
- > Ideal for artwork, displays, and feature lighting
- > Smooth directional adjustment for precise highlighting
- > Elegant matte finish for premium aesthetics

PRODUCT DIMENSION



BEAM ANGLE



 Surface Mount	 Operating Voltage 110-290V AC	 Aluminium Housing	 Surge Protection Upto 4KV	 Tiltable Focused Illumination	 3IN1 Mood Lighting
---	--	---	--	---	--

Technical Details

Item Code	ZSFLPBKG2312WWN
Wattage	12W
Length	58mm
Height	86mm
PKG.	50 Pcs.
Price ₹	1500.00

Led Type : COB
LM/W : 100LM/W
CCT : 3000+4000+6500K

Beam Angle : 36°
CRI : 91
Body Colour : BLK+RG

Voltage : AC110~300V
Current : 280-300mA



DOME SURFACE
CYLINDER DOWNLIGHT

BIOCON Pro
LED LIGHTING

DOME SURFACE CYLINDER DOWNLIGHT



PRODUCT FEATURES AND BENEFIT

- > Surface-mounted cylinder design for modern ceiling lighting
- > Premium aluminium housing for durability and heat dissipation
- > Deep reflector optics for focused and glare-controlled illumination
- > Energy-efficient LED source for low power consumption
- > Ideal for accent and architectural lighting
- > Perfect for homes, showrooms, hotels, and retail spaces
- > Modern minimalist design for contemporary interiors

PRODUCT DIMENSION



BEAM ANGLE

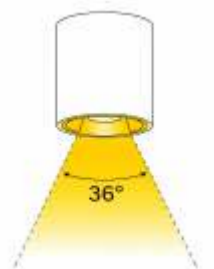

Surface Mount



Operating Voltage
110-290V AC



Aluminium
Housing



Surge Protection
Upto 4KV



Focused
Halogen Effect

Technical Details

Item Code	DCSFLBK3007WW	DCSFLBK3012WW	DCSFLBK3018WW
Wattage	7W	12W	18W
Length	62mm	62mm	62mm
Height	72mm	72mm	72mm
PKG.	40 Pcs.	40 Pcs.	20 Pcs.
Price ₹	700.00	950.00	1500.00

Led Type : COB
LM/W : 100LM/W
CCT : 3000/4000/6500K

Beam Angle : 36°
CRI : 91
Body Colour : BLK+RG

Voltage : AC110~300V
Current : 280-300mA



DOME SURFACE CYLINDER DOWNLIGHT

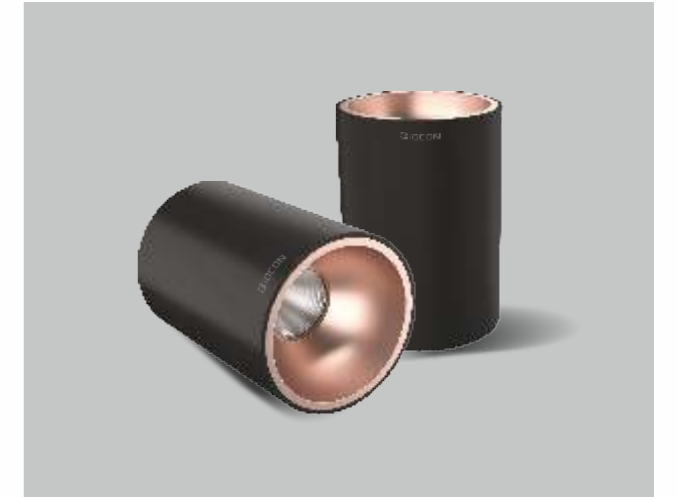

PRODUCT FEATURES AND BENEFIT

- > Surface-mounted cylinder design for modern ceiling lighting
- > Premium aluminium housing for durability and heat dissipation
- > Deep reflector optics for focused and glare-controlled illumination
- > Energy-efficient LED source for low power consumption
- > Ideal for accent and architectural lighting
- > Perfect for homes, showrooms, hotels, and retail spaces
- > Modern minimalist design for contemporary interiors

PRODUCT DIMENSION

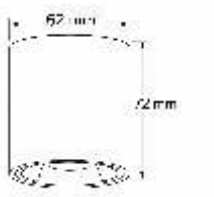

BEAM ANGLE

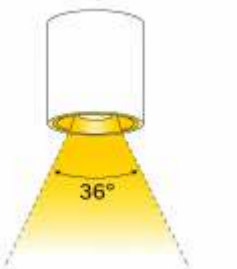

Surface Mount |
 Operating Voltage 110-290V AC |
 Aluminium Housing |
 Surge Protection Upto 4KV |
 Focused Halogen Effect |
 3IN1 Mood Lighting

Technical Details

Item Code	DCSFLBK3507WWN	DCSFLBK3512WWN	DCSFLBK3518WWN
Wattage	7W	12W	18W
Length	62mm	62mm	62mm
Height	72mm	72mm	72mm
PKG.	40 Pcs.	40 Pcs.	20 Pcs.
Price ₹	900.00	1250.00	1800.00

Led Type : COB
 LM/W : 100LM/W
 CCT : 3000+4000+6500K

Beam Angle : 36°
 CRI : 91
 Body Colour : BLK+RG

Voltage : AC110~300V
 Current : 280-300mA

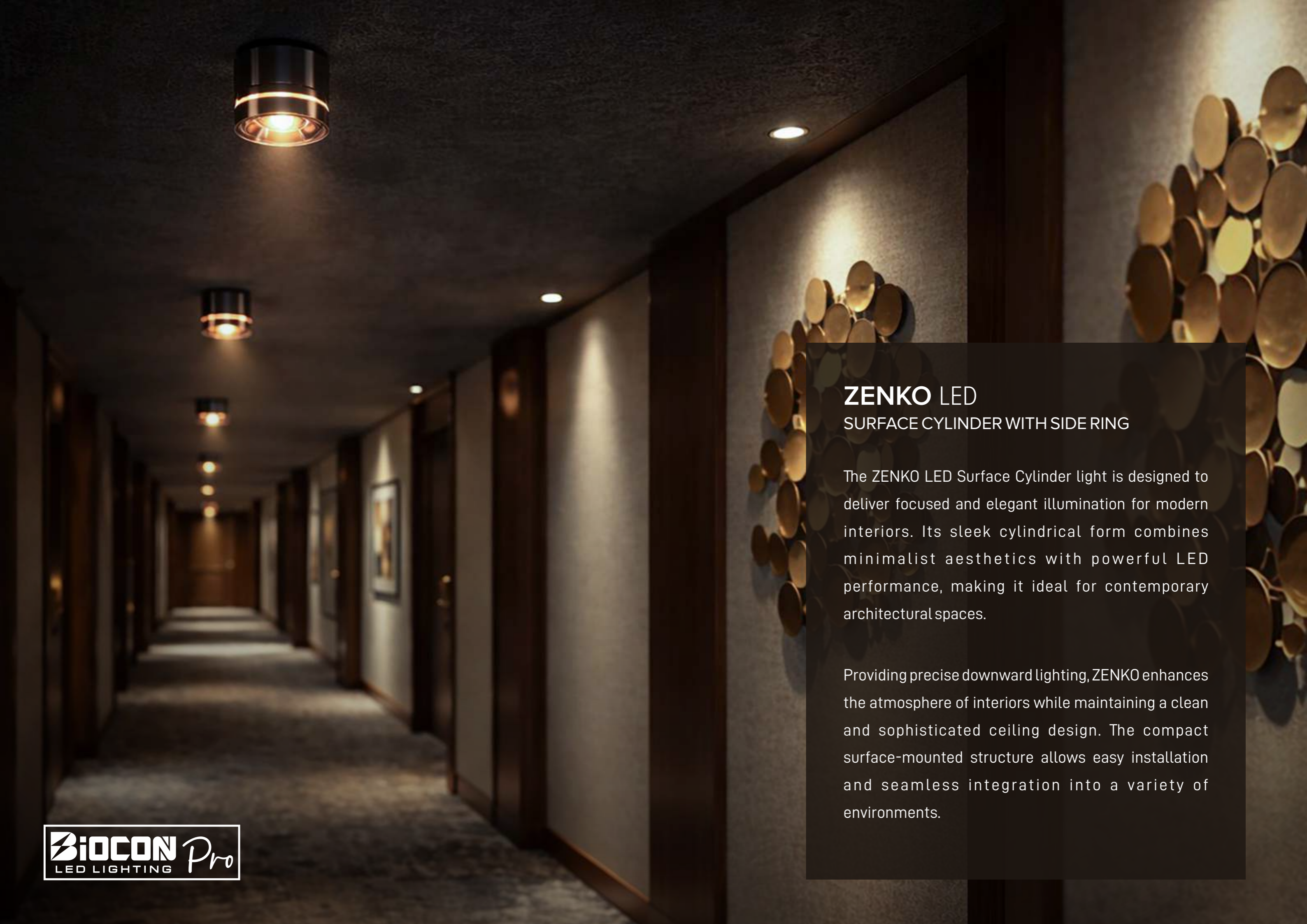

ZENKO LED SURFACE CYLINDER WITH SIDE RING

The ZENKO LED Surface Cylinder light is designed to deliver focused and elegant illumination for modern interiors. Its sleek cylindrical form combines minimalist aesthetics with powerful LED performance, making it ideal for contemporary architectural spaces.

Providing precise downward lighting, ZENKO enhances the atmosphere of interiors while maintaining a clean and sophisticated ceiling design. The compact surface-mounted structure allows easy installation and seamless integration into a variety of environments.



ZENKO LED

SURFACE CYLINDER WITH SIDE RING



PRODUCT FEATURES AND BENEFIT

- > Surface-mounted cylinder design for modern architectural lighting
- > Decorative glowing side ring for premium ambient effect
- > Premium aluminium housing for durability and heat dissipation
- > Energy-efficient LED source for low power consumption
- > Focused beam illumination for accent lighting
- > Ideal for highlighting interiors and décor elements
- > Ideal for hotels, restaurants, art galleries, salons, airports malls, etc
- > Modern minimalist design for premium interiors

PRODUCT DIMENSION

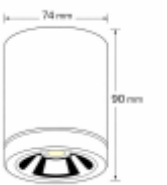

BEAM ANGLE

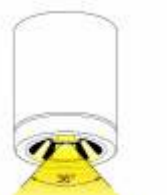

Surface Mount	Operating Voltage 110-290V AC	Aluminium Housing	Surge Protection Upto 4KV	Focused Halogen Effect	3IN1 Mood Lighting
---------------	----------------------------------	-------------------	------------------------------	---------------------------	-----------------------

Technical Details

Item Code	ZSFLPBKRG2012WWN
Wattage	12W
Length	74mm
Height	90mm
PKG.	50 Pcs.
Price ₹	1300.00

Led Type : COB
LM/W : 100LM/W
CCT : 3000+4000+6500K

Beam Angle : 36°
CRI : 91
Body Colour : BLK+RG

Voltage : AC110~300V
Current : 280-300mA



ELIPSE LED
ELIPSE SURFACE CYLINDER

BIOCON Pro
LED LIGHTING



ELIPSE LED

ELIPSE SURFACE CYLINDER



PRODUCT FEATURES AND BENEFIT

- > Ultra-slim surface design for clean modern ceilings
- > Wide beam illumination for smooth ambient lighting
- > Premium aluminium housing for durability and heat control
- > High-efficiency LED module for bright uniform output
- > Low glare diffuser for comfortable lighting experience
- > Ideal for bedrooms, corridors, offices, and hotel rooms
- > Minimalist round profile for contemporary interiors

PRODUCT DIMENSION

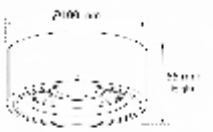

BEAM ANGLE



Surface Mount	Operating Voltage 110-300V AC	Aluminium Housing	Surge Protection Upto 4KV	Focused Halogen Effect	3IN1 Mood Lighting
---------------	----------------------------------	-------------------	------------------------------	------------------------	--------------------

Technical Details

Item Code	ESFLPGBK2212WWN
Wattage	12W
Length	100mm
Height	55mm
PKG.	40 Pcs.
Price ₹	1200.00

Led Type : SMD
LM/W : 100LM/W
CCT : 3000+4000+6500K

Beam Angle : 120°
CRI : 91
Body Colour : Copper/BLK

Voltage : AC110~300V
Current : 280-300mA



DAWN LED
SURFACE CYLINDER

BIOCON Pro
LED LIGHTING

DAWN LED
SURFACE CYLINDER





DAWN LED SURFACE CYLINDER



PRODUCT FEATURES AND BENEFIT

- > Surface-mounted cylindrical design for modern ceiling lighting
- > Focused downward beam for clean accent illumination
- > Die-cast aluminium body for strength and heat dissipation
- > High-efficiency LED module for bright, stable output
- > Compact architectural profile for minimalist interiors
- > Ideal for corridors, hotel rooms, and office spaces
- > Smooth beam distribution for comfortable lighting
- > Contemporary matte finish for premium aesthetics

PRODUCT DIMENSION



BEAM ANGLE

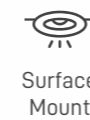

Surface Mount



Operating Voltage
110-300V AC



Aluminium
Housing



Surge Protection
Upto 4KV



Focused
Halogen Effect



3IN1 Mood
Lighting

Technical Details

Item Code	DSFLPSGRG2112WWN
Wattage	12W
Length	83mm
Height	65mm
PKG.	40 Pcs.
Price ₹	1600.00

Led Type : COB

LM/W : 100LM/W

CCT : 3000+4000+6500K

Beam Angle : 36°

CRI : 91

Body Colour : Space Grey

Voltage : AC110~300V

Current : 280-300mA



SPARK FLOOD
LIGHT WITH DRIVER







SPARK FLOOD LIGHT



PRODUCT FEATURES AND BENEFIT

- > High-power LED output for maximum area illumination
- > Rugged, heavy-duty construction for outdoor durability
- > Die-cast aluminium housing for efficient heat dissipation
- > High-lumen efficiency with low energy consumption
- > Wide beam angle for uniform light distribution
- > Weatherproof design with IP65 / IP66 protection
- > High surge protection for reliable performance



 Operating Voltage 110-300V AC	 Aluminium Housing	 Surge Protection Upto 4KV	 Heavy Duty Body
---	---	---	---

Technical Details

Item Code	SFL2230WH	SFL2250WH	SFL22100WH	SFL22150WH	SFL22200WH
Wattage	30W	50W	100W	150W	200W
PKG.	20 Pcs.	10 Pcs.	10 Pcs.	05 Pcs.	05 Pcs.
Price ₹	1275.00	2200.00	3500.00	5000.00	6200.00

Led Type : SMD
LM/W : 100LM/W
CCT : 3000/6500K

Beam Angle : 180°
CRI : 80

Voltage : AC110~300V
Current : 280-300mA



SPARK HEAVY DUTY FLOOD LIGHT







PRODUCT FEATURES AND BENEFIT

- > High-power LED output for maximum area illumination
- > Rugged, heavy-duty construction for outdoor durability
- > Die-cast aluminium housing for efficient heat dissipation
- > High-lumen efficiency with low energy consumption
- > Wide beam angle for uniform light distribution
- > Weatherproof design with IP65 / IP66 protection
- > High surge protection for reliable performance

BEAM ANGLE



Beam Angle 120°

 Operating Voltage 110-300V AC	 Aluminium Housing	 Surge Protection Upto 4KV	 Heavy Duty Body
---	---	---	---

Technical Details

Item Code	SFL22300WH	SFL22500WH
Wattage	300W	500W
PKG.	5 Pcs.	2 Pcs.
Price ₹	10000.00	16000.00

Led Type : SMD
LM/W : 100LM/W
CCT : 6500K

Beam Angle : 180°
CRI : 80

Voltage : AC110~300V
Current : 280-300mA



ROADSTAR LED
STREET LIGHT

BIOCON Pro
LED LIGHTING



ROADSTAR LED

STREET LIGHT



PRODUCT FEATURES AND BENEFIT

- > High-efficiency LED for bright and uniform road illumination
- > Optimized optical lens for wide and consistent light distribution
- > Sleek aerodynamic design for reduced wind resistance
- > Die-cast aluminium housing for superior heat dissipation
- > Weatherproof construction with IP65 / IP66 protection
- > High surge protection for stable outdoor performance
- > Anti-glare lighting for enhanced road visibility & safety

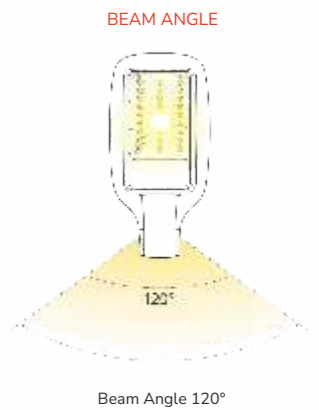

 Operating Voltage 110-300V AC	 Aluminium Housing	 Surge Protection Upto 4KV
---	---	---

Technical Details

Item Code	RSL2224WH	RSL2236WH	RSL2250WH	RSL22100WH
Wattage	24W	36W	50W	100W
PKG.	20 Pcs.	20 Pcs.	10 Pcs.	05 Pcs.
Price ₹	970.00	1350.00	1700.00	3000.00

Led Type : SMD
LM/W : 100LM/W
CCT : 6500K

Beam Angle : 120°
CRI : 80

Voltage : AC110~300V
Current : 280-300mA

MAGNETIC TRACK LIGHTS



REEF LED MAGNETIC RECESSED TRACK RAIL

The Magnetic Rail is the foundation of modern magnetic lighting systems, designed to provide a clean, flexible, and highly functional lighting solution for contemporary interiors. Engineered for seamless integration, the rail allows magnetic light fixtures to be easily installed, removed, or repositioned without the need for tools.

Its sleek architectural profile blends perfectly with modern ceilings while supporting a wide range of magnetic lighting modules including spot lights, linear lights, diffuser lights, and adjustable fixtures.



REEF LED

MAGNETIC RECESSED TRACK RAIL



PRODUCT FEATURES AND BENEFIT

- > Ultra-slim magnetic rail profile for minimalist ceiling integration
- > Magnetic mounting system for quick fixture installation and adjustment
- > Premium aluminium construction for strength and durability
- > Low-voltage track system for safe and efficient operation
- > Modular design for flexible lighting configurations
- > Compatible with magnetic spotlights, diffusers, and linear lights
- > Ideal for modern offices, retail stores, galleries, and hospitality spaces
- > Clean architectural finish for contemporary interiors
- > Easy installation and maintenance
- > Perfect for seamless magnetic lighting systems

PRODUCT DIMENSION

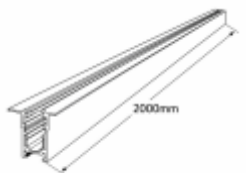
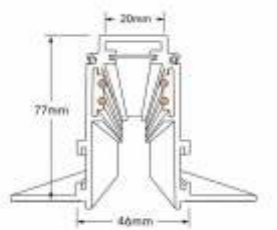

Recessed Mount



Aluminium Housing



20 mm Series

Technical Details

Item Code	RMTRPBK2003M
Length	2MTR
Width	46mm
Height	77mm
Price ₹	4000.00





LINO LED

MAGNETIC SURFACE TRACK RAIL



PRODUCT FEATURES AND BENEFIT

- > Magnetic rail system for flexible lighting configurations
- > Strong magnetic connection for secure fixture mounting
- > Modular track design for customizable lighting layouts
- > Premium aluminium construction for durability and stability
- > Compatible with magnetic lighting fixtures
- > Ideal for modern commercial and architectural lighting setups
- > Clean linear profile for seamless ceiling integration
- > Low-voltage track system for safe and efficient operation

PRODUCT DIMENSION

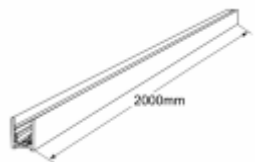
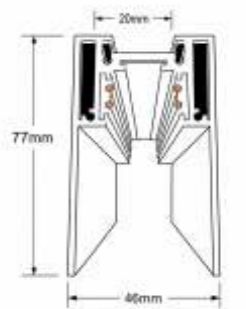

Surface Mount



Aluminium Housing



20 mm Series

Technical Details

Item Code	LMTRPBK2103M
Length	2MTR
Width	46mm
Height	77mm
Price ₹	3800.00



CORAL LED

MOVABLE MAGNETIC LINEAR LIGHT

The CORAL LED Magnetic Linear Light is designed to bring flexibility and precision to modern lighting systems. Featuring an advanced magnetic track mechanism, the fixture can be easily repositioned to create customized lighting layouts that adapt to changing interior needs.

Its sleek linear design delivers powerful and evenly distributed illumination while maintaining a minimal architectural appearance. The magnetic installation allows effortless adjustment, making it ideal for dynamic lighting environments.

CORAL LED
MOVABLE MAGNETIC LINEAR LIGHT





CORAL LED

MOVABLE MAGNETIC LINEAR LIGHT



PRODUCT FEATURES AND BENEFIT

- > Movable magnetic design for flexible positioning on track rails
- > Linear multi-LED module for uniform and powerful illumination
- > Premium aluminium housing for durability and heat dissipation
- > Energy-efficient LED technology for low power consumption
- > Focused beam lighting for accent and display illumination
- > Ideal for retail stores, galleries, museums, and showrooms
- > Modern slim profile for clean architectural aesthetics
- > Easy installation and repositioning on magnetic track systems
- > Perfect for highlighting products, artwork, and displays

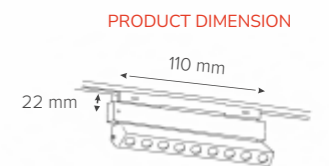

Track Mount	Operating Voltage 110-310V AC	Aluminium Housing	Surge Protection Upto 4KV	Tilttable Focused Illumination	3IN1 Mood Lighting
-------------	----------------------------------	-------------------	------------------------------	--------------------------------	--------------------

Technical Details

Item Code	CMLLPBK2006WWN	CMLLPBK2012WWN
Wattage	6W	12W
Length	110mm	220mm
Height	22mm	22mm
PKG.	50 Pcs.	30 Pcs.
Price ₹	1200.00	1800.00

Led Type : COB
LM/W : 100LM/W
CCT : 3000+4000+6500K

Beam Angle : 36°
CRI : 91

Voltage : AC110~300V
Current : 280-300mA

SCUBA LED

GRILLE MAGNETIC LINEAR TRACK LIGHT

The SCUBA Magnetic Track Light is designed to deliver precise linear illumination with maximum flexibility for modern architectural spaces. Its sleek rectangular design integrates seamlessly into magnetic track systems, allowing easy installation and effortless repositioning.

Equipped with advanced LED technology, SCUBA provides uniform light distribution, energy efficiency, and excellent visual comfort. The magnetic mounting system allows the fixture to be quickly adjusted along the track, offering complete freedom in lighting design.

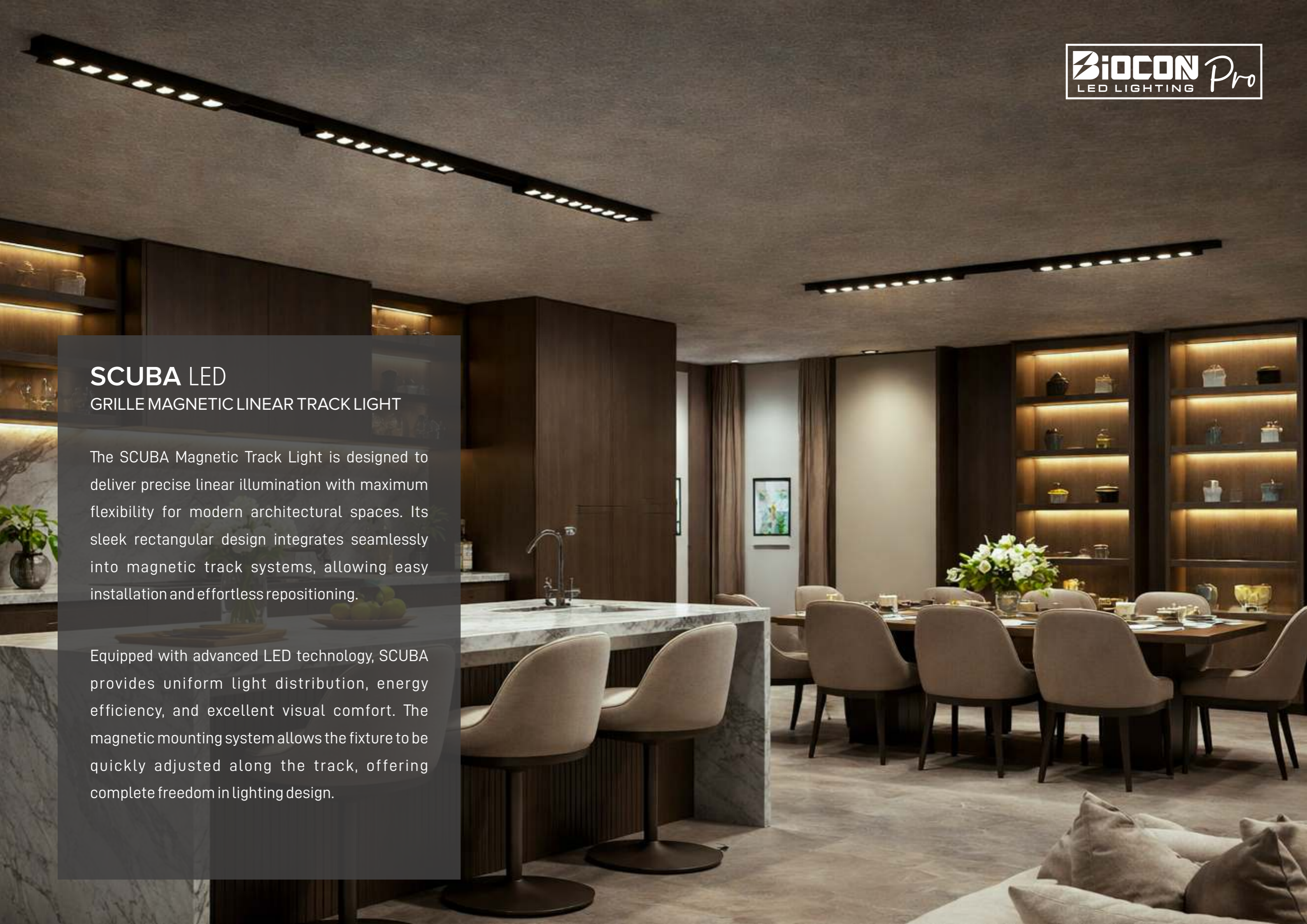



SCUBA LED

GRILLE MAGNETIC LINEAR TRACK LIGHT



PRODUCT FEATURES AND BENEFIT

- > Magnetic track compatibility for quick installation and repositioning
- > Linear multi-LED module for uniform and powerful illumination
- > Precision beam optics for controlled accent lighting
- > Slim architectural profile for modern lighting systems
- > Premium aluminium housing for durability and heat dissipation
- > Ideal for retail stores, galleries, and commercial interiors
- > Energy-efficient LED technology for reduced power consumption

PRODUCT DIMENSION

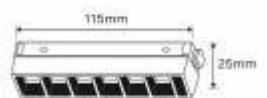

BEAM ANGLE

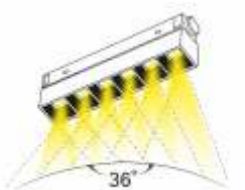

Track Mount	Operating Voltage 110-310V AC	Aluminium Housing	Surge Protection Upto 4KV	Focused Beam Effect	3IN1 Mood Lighting
-------------	----------------------------------	-------------------	------------------------------	---------------------	--------------------

Technical Details

Item Code	SMLLPBK2106WWN	SMLLPBK2112WWN	SMLLPBK2118WWN
Wattage	6W	12W	18W
Length	115mm	223mm	331mm
Height	25mm	25mm	25mm
PKG.	50 Pcs.	20 Pcs.	20 Pcs.
Price ₹	750.00	1200.00	1500.00

Led Type : COB
LM/W : 100LM/W
CCT : 3000+4000+6500K

Beam Angle : 36°
CRI : 91

Voltage : AC110~300V
Current : 280-300mA

TIDAL LED MAGNETIC LINEAR TRACK DIFFUSER LIGHT

The TIDAL Magnetic Track Diffuser Light is designed to deliver smooth and uniform illumination for modern interior environments. Its linear diffuser design provides soft, glare-free lighting that creates a comfortable and balanced atmosphere.

Integrated with a magnetic track system, TIDAL allows effortless installation and flexible positioning, enabling lighting layouts to be adjusted according to changing interior needs. The diffuser technology ensures even light distribution while maintaining a sleek and minimal architectural appearance.



TIDAL LED
MAGNETIC LINEAR TRACK DIFFUSER LIGHT





TIDAL LED

MAGNETIC LINEAR TRACK DIFFUSER LIGHT



PRODUCT FEATURES AND BENEFIT

- > Magnetic track mounting for easy installation and repositioning
- > Diffused linear lighting for soft and uniform illumination
- > Glare-free light output for comfortable visual experience
- > Slim minimalist design for modern architectural spaces
- > Premium aluminium housing for durability and heat management
- > Ideal for homes, showrooms, galleries, hotels and commercial interiors
- > Energy-efficient LED technology for low power consumption
- > Seamless integration with magnetic track lighting systems

PRODUCT DIMENSION



BEAM ANGLE



 Track Mount	 Operating Voltage 110-300V AC	 Aluminium Housing	 Surge Protection Upto 4KV	 3IN1 Mood Lighting
---	--	---	--	--

Technical Details

Item Code	TMLLPBK2206WWN	TMLLPBK2212WWN	TMLLPBK2218WWN
Wattage	6W	12W	18W
Length	300mm	607mm	907mm
Height	22mm	22mm	22mm
PKG.	20 Pcs.	20 Pcs.	30 Pcs.
Price ₹	650.00	1300.00	2000.00

Led Type : SMD
LM/W : 100LM/W
CCT : 3000+4000+6500K

Beam Angle : 120°
CRI : 91

Voltage : AC110~300V
Current : 280-300mA



BLISS LED
MAGNETIC TRACK LIGHT

BIOCON Pro
LED LIGHTING



BLISS LED

MAGNETIC TRACK LIGHT



PRODUCT FEATURES AND BENEFIT

- > Magnetic track compatibility for quick installation and repositioning
- > Adjustable spotlight head for flexible beam direction
- > High-efficiency LED module for bright focused illumination
- > Premium aluminium body for durability and heat dissipation
- > Smooth tilt and rotation for precise accent lighting
- > Ideal for retail stores, galleries, and display lighting
- > Slim cylindrical design for modern architectural aesthetics

PRODUCT DIMENSION

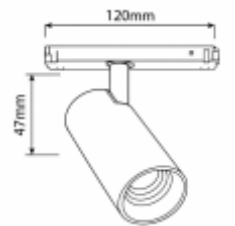

BEAM ANGLE



 Track Mount	 Operating Voltage 110-300V AC	 Aluminium Housing	 Surge Protection Upto 4KV	 Tiltable Focused Illumination	 3IN1 Mood Lighting
---	--	---	--	---	--

Technical Details

Item Code	BMTLPBK2012WWN	BMTLPBK2018WWN	BMTLPBK2024WWN
Wattage	12W	18W	24W
Length	47mm	57mm	65mm
Height	120mm	135mm	135mm
PKG.	20 Pcs.	20 Pcs.	20 Pcs.
Price ₹	1650.00	2100.00	2750.00

Led Type : COB
LM/W : 100LM/W
CCT : 3000+4000+6500K

Beam Angle : 36°
CRI : 91
Body Colour : Black

Voltage : AC110~300V
Current : 280-300mA

ELIOS LED MAGNETIC HANGING CEILING LIGHT

The ELIOS Ceiling Hanging Magnetic Track Light is designed to bring flexibility and modern elegance to magnetic lighting systems. Suspended from the ceiling, it allows magnetic track fixtures to be positioned at an optimal height, creating dynamic and visually striking lighting arrangements.

Its sleek suspended structure enhances contemporary interiors while supporting a variety of magnetic lighting modules including spot lights, linear lights, and diffuser lights. The adjustable hanging system makes it ideal for spaces with higher ceilings or where a floating lighting effect is desired.





ELIOS LED

MAGNETIC HANGING CEILING LIGHT

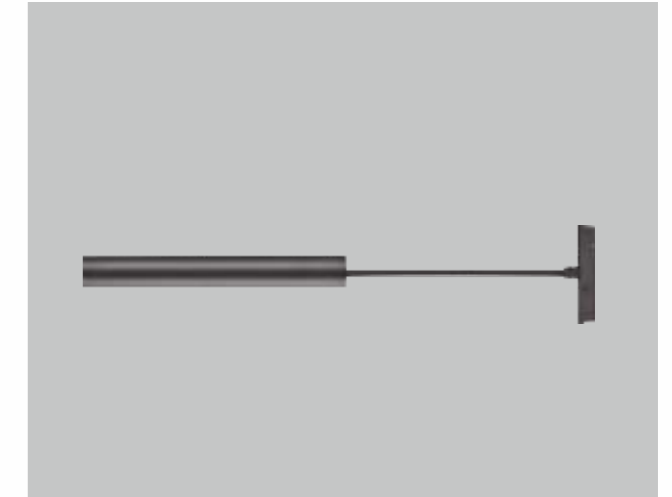

PRODUCT FEATURES AND BENEFIT

- > Suspended magnetic track system for modern architectural lighting
- > Adjustable hanging installation for customized ceiling height
- > Magnetic mounting rail for quick fixture placement and repositioning
- > Premium aluminium construction for durability and strength
- > Low-voltage magnetic track system for safe and efficient operation
- > Flexible lighting layout compatible with multiple magnetic fixtures
- > Ideal for showrooms, galleries, offices, and retail spaces
- > Minimalist suspended design for contemporary interiors

PRODUCT DIMENSION

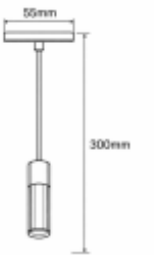

BEAM ANGLE



 Track Mount	 Operating Voltage 110-300V AC	 Aluminium Housing	 Surge Protection Upto 4KV	 Focused Halogen Effect	 3IN1 Mood Lighting
---	--	---	--	---	---

Technical Details

Item Code	EMHLPBK2012WWN
Wattage	12W
Length	55mm
Height	300mm
PKG.	20 Pcs.
Price ₹	5500.00

Led Type : COB
LM/W : 100LM/W
CCT : 3000+4000+6500K

Beam Angle : 36°
CRI : 91
Body Colour : Black

Voltage : AC110~300V
Current : 280-300mA

PREMIUM PRECISION CONNECTIVITY SOLUTIONS

FLEXIBLE
CONNECTOR CABLE



DUAL SENSING
CONTACTS

1 High-Performance Sensors

INTEGRATED SENSOR
& POWER SYSTEM



COMPACT
PROFILE

2 Secure Interconnects

PRECISION ALIGNMENT
BRACKETS



DURABLE
METAL ALLOY

3 High-Performance Sensors

FUNCTIONAL CONTROL
BUTTONS



INTEGRATED
CABLE INPUT

4 Modular Design

COMPLETE INTERCONNECT ASSEMBLY



STYLISH & ROBUST DESIGN
DESIGN

5 Secure Interconnects

BUILDING BETTER CONNECTIONS

V-MAG LED

Magnetic Track Driver 100W CCT

VMMDRP20100W
Price : ₹ **3500.00**
PKG : 50 Pcs.



Magnetic Track Driver 200W CCT

VMMDRP20200W
Price : ₹ **4500.00**
PKG : 50 Pcs.



Straight Magnetic Jointer

VMSJMAP2200
Price : ₹ **250.00**
PKG : 100 Pcs.



Corner Magnetic Jointer

VMCJMAP2200
Price : ₹ **375.00**
PKG : 100 Pcs.



Magnetic Hanging Kit

VMHKMAP2000
Price : ₹ **500.00**



Surface Magnetic Aluminium Plate

VMSFMAP2100
Price : ₹ **125.00**



Recessed Magnetic Aluminium Connector

VMRCMAP2100
Price : ₹ **150.00**





AIR LED
TRACK LIGHT

BIOCON Pro
LED LIGHTING



AIR LED

TRACK LIGHT WITH SWITCH



PRODUCT FEATURES AND BENEFIT

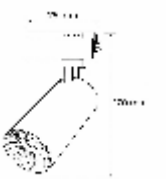

- > Adjustable track-mounted spotlight for flexible lighting direction
- > High-performance LED module for focused illumination
- > Premium aluminium housing for durability and heat dissipation
- > Rotatable and tiltable head for precise beam control
- > Slim cylindrical design for modern architectural lighting
- > Ideal for retail stores, galleries, and display lighting
- > Uniform beam projection for highlighting products and artwork
- > Energy-efficient LED technology for reduced power consumption

PRODUCT DIMENSION



BEAM ANGLE



 Track Mount	 Operating Voltage 110-300V AC	 Aluminium Housing	 Surge Protection Upto 4KV	 Tiltable Focused Illumination	 3IN1 Mood Lighting
---	--	---	--	--	---

Technical Details

Item Code	ATLBK2130WWN
Wattage	30W
Length	75mm
Height	170mm
PKG.	10 Pcs.
Price ₹	1800.00

Led Type : COB
LM/W : 100LM/W
CCT : 3000+4000+6500K

Beam Angle : 36°
CRI : 91
Body Colour : Black

Voltage : AC110~300V
Current : 280-300mA



FIZO LED 3in1
TRACK LINEAR FITTING COLOUR CHANGEABLE

BIOCON Pro
LED LIGHTING



FIZO LED 3in1

TRACK LINEAR FITTING COLOUR CHANGEABLE



PRODUCT FEATURES AND BENEFIT

- > Modular linear track system with square cup design for a bold architectural look
- > Precision lighting modules for focused and uniform illumination
- > Clean geometric aesthetics for modern interior spaces
- > Flexible positioning on track for custom lighting layouts
- > High-efficiency LED for bright and energy-saving performance
- > Glare-controlled optics for comfortable visual experience
- > Durable aluminium construction with excellent heat dissipation

BEAM ANGLE

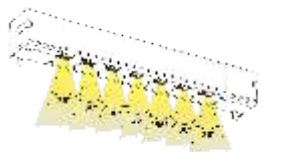

Beam Angle 36°

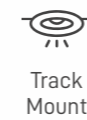

Track Mount



Operating Voltage
110-300V AC



Aluminium
Housing



Surge Protection
Upto 4KV



3IN1 Mood
Lighting

Technical Details

Item Code	FLLBK2015WWN	FLLBK2030WWN
Wattage	15W	30W
Cutout	12 Inch	20 Inch
PKG.	30 Pcs.	20 Pcs.
Price ₹	1200.00	1800.00

Led Type : COB
LM/W : 100LM/W
CCT : 3000+4000+6500K

Beam Angle : 36°
CRI : 85
Body Colour : Black

Voltage : AC110~300V
Current : 280-300mA



B-HANG LED 3in1
LINEAR LIGHT COLOUR CHANGEABLE

BIOCON Pro
LED LIGHTING



B-HANG LED 3in1

LINEAR LIGHT COLOUR CHANGEABLE

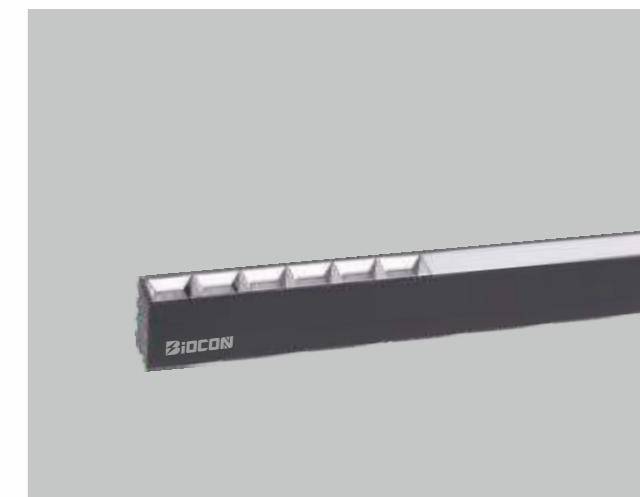

PRODUCT FEATURES AND BENEFIT

- > Adjustable suspension cables for customizable height installation
- > Glare-free diffuser for soft and comfortable lighting and square cups for even lighting and luxurious look
- > High-efficiency LED for energy-saving performance
- > Minimalistic profile for premium interior aesthetics
- > Ideal for creating linear lighting patterns & visual symmetry
- > Durable aluminium body with excellent heat management
- > Long lifespan with low maintenance operation

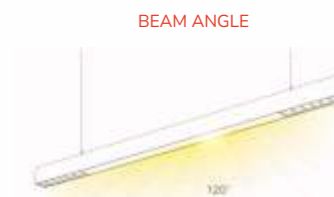

Beam Angle 120°

 Surface Mount	 Operating Voltage 110-300V AC	 Aluminium Housing	 Surge Protection Upto 4KV	 3IN1 Mood Lighting
--	---	--	---	---

Technical Details

Item Code	BHLLBK2142WWN
Wattage	42W
Cutout	48 Inch
PKG.	10 Pcs.
Price ₹	4000.00

Led Type : SMD
LM/W : 100LM/W
CCT : 3000+4000+6500K

Beam Angle : 120°
CRI : 80

Voltage : AC110~300V
Current : 280-300mA



B-DROP COB 3in1
LINEAR LIGHT COLOUR CHANGEABLE





B-DROP COB 3in1

LINEAR LIGHT COLOUR CHANGEABLE



PRODUCT FEATURES AND BENEFIT

- > Adjustable suspension cables for customizable height installation
- > Glare-free diffuser for soft and comfortable lighting
- > High-efficiency LED for energy-saving performance
- > Minimalistic profile for premium interior aesthetics
- > Ideal for creating linear lighting patterns & visual symmetry
- > Durable aluminium body with excellent heat management
- > Long lifespan with low maintenance operation

BEAM ANGLE

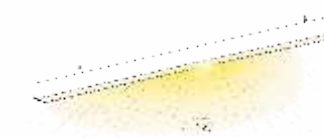

Beam Angle 120°



Surface Mount



Operating Voltage
110-300V AC



Aluminium
Housing



Surge Protection
Upto 4KV



3IN1 Mood
Lighting

Technical Details

Item Code	BDLLBK2248WWN
Wattage	48W
Cutout	48 Inch
PKG.	10 Pcs.
Price ₹	3000.00

Led Type : SMD
LM/W : 100LM/W
CCT : 3000+4000+6500K

Beam Angle : 120°
CRI : 80

Voltage : AC110~300V
Current : 280-300mA



AIR LED 3in1

MIRROR LIGHT COLOUR CHANGEABLE

BIOCON Pro
LED LIGHTING



AIR LED 3in1

MIRROR LIGHT COLOUR CHANGEABLE



PRODUCT FEATURES AND BENEFIT

- > Soft, glare-free output for comfortable eye experience
- > Sleek and modern design for luxury interiors
- > High-quality diffuser for even light distribution
- > Energy-efficient LED with long lifespan
- > Moisture-resistant design suitable for bathroom environments
- > Easy installation with clean wall integration
- > Premium finish to complement modern décor

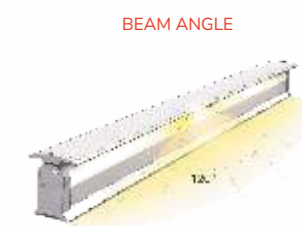

Beam Angle 120°



Wall Mount



Operating Voltage 110-300V AC



Aluminium Housing



Surge Protection Upto 4KV



3IN1 Mood Lighting

Technical Details

Item Code	AML2012WWN
Wattage	12W
Size	16 Inch
PKG.	20 Pcs.
Price ₹	1200.00

Led Type : SMD
LM/W : 100LM/W
CCT : 3000+4000+6500K

Beam Angle : 120°
CRI : 80

Voltage : AC110~300V
Current : 280-300mA

WALL LIGHTS

BIOCON Pro
LED LIGHTING



RIGEL LED OUT DOOR WALL LIGHT

Enhance your exterior spaces with the Rigel Wall Light, a modern lighting fixture designed to create stunning architectural effects. Its circular design emits light both upward and downward, forming a beautiful cross-beam pattern that adds depth, warmth, and elegance to any wall.

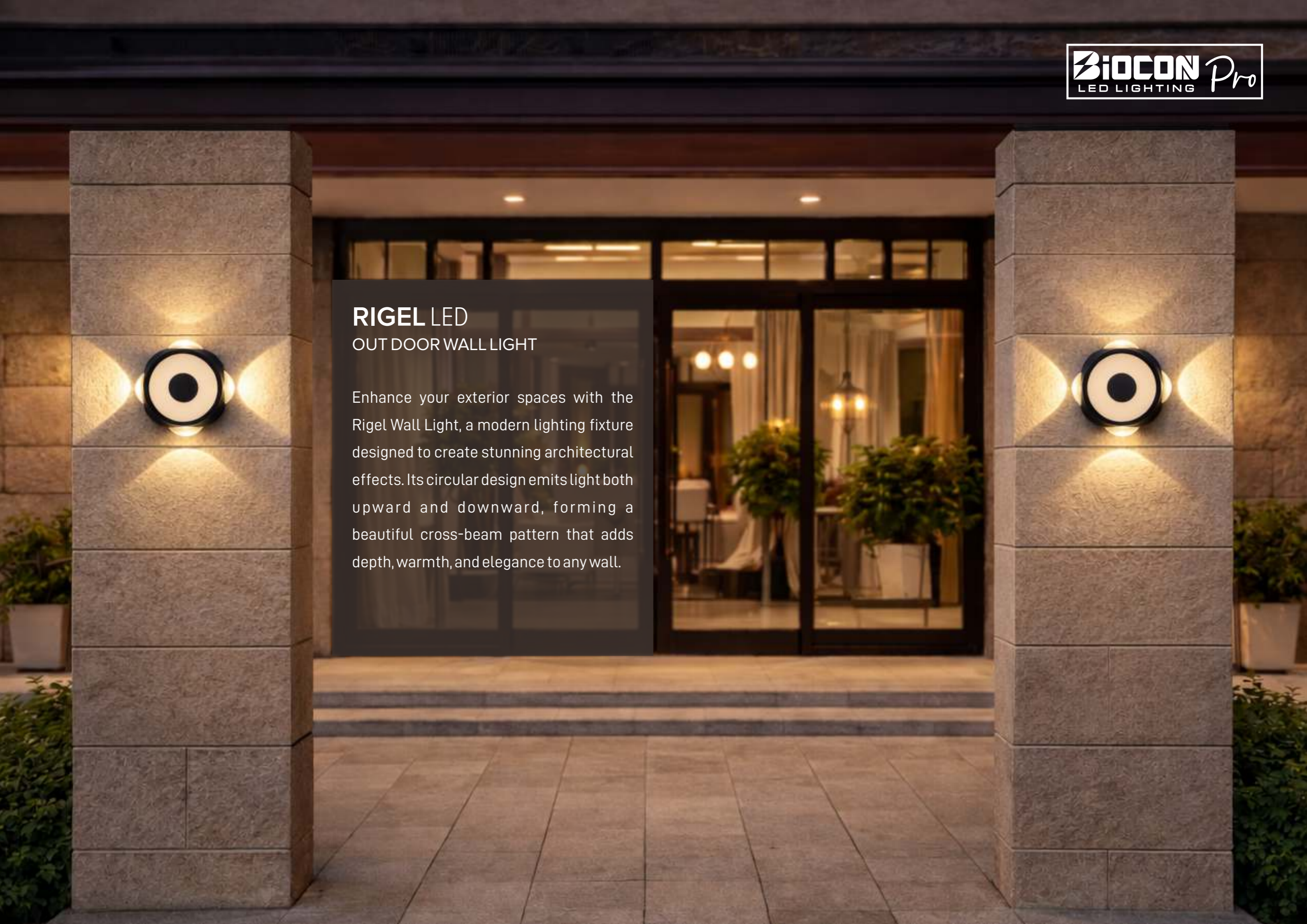



RIGEL LED OUT DOOR WALL LIGHT



PRODUCT FEATURES AND BENEFIT

- > Premium aluminium housing for durability and superior heat dissipation
- > 360° decorative light pattern for elegant wall illumination
- > Energy-efficient LED source for low power consumption
- > Instant start with flicker-free lighting
- > Modern circular design for contemporary interiors
- > Ideal for decorative wall accent lighting
- > Perfect for living rooms, corridors, hotels, and galleries
- > Long-lasting performance with minimal maintenance
- > Soft ambient lighting for a premium atmosphere
- > Suitable for both indoor and outdoor applications



Wall
Mount



Operating Voltage
110-300V AC



Aluminium
Housing



Surge Protection
Upto 4KV



Waterproof
Driver

Technical Details

Item Code	ROWLP2006WW
Wattage	6W
PKG.	30 Pcs.
Price ₹	750.00

Led Type : SMT

CCT : 3000K

LED Make : Bridgelux

CRI : 91

Body Colour : Grey

Water Proof : IP65

CAPELLA LED OUT DOOR WALL LIGHT

The Capella Wall Light combines modern design with architectural lighting effects to enhance exterior walls and façades. Its sleek curved form projects light both upward and downward, creating a striking layered illumination that adds depth and character to any space.

A sign for a hotel and resort, featuring the text 'HOTEL & RESORT' in a serif font, with five gold stars below it. The sign is mounted on a textured wall and is illuminated by four wall-mounted lights.



CAPELLA LED OUT DOOR WALL LIGHT



PRODUCT FEATURES AND BENEFIT

- > Elegant up & down lighting effect for decorative wall illumination
- > Premium aluminium housing for durability and heat dissipation
- > Energy-efficient LED for low power consumption
- > Instant start with flicker-free illumination
- > Operating temperature: -10°C to 45°C
- > Ideal for accent and architectural lighting
- > Modern compact design suitable for premium interiors
- > Perfect for corridors, hotel lobbies, living rooms, and galleries
- > Suitable for both indoor and outdoor applications only



Wall
Mount



Operating Voltage
110-300V AC



Aluminium
Housing



Surge Protection
Upto 4KV



Waterproof
Driver

Technical Details

Item Code	COWLP2102WW
Wattage	2W
PKG.	30 Pcs.
Price ₹	1000.00

Led Type : SMT

CCT : 3000K

LED Make : Bridgelux

CRI : 91

Body Colour : Black

Water Proof : IP66

ORION LED OUT DOOR WALL LIGHT

The Orion Wall Light blends modern design with elegant illumination to enhance architectural spaces. Its distinctive frame and soft diffused lighting create a welcoming glow that highlights entry ways and exterior walls beautifully.



ORION LED OUT DOOR WALL LIGHT



PRODUCT FEATURES AND BENEFIT

- > Stylish curved design for modern decorative wall lighting
- > Premium aluminium housing for durability and heat dissipation
- > Soft diffused illumination for comfortable ambient lighting
- > Energy-efficient LED source for reduced power consumption
- > Elegant light distribution for decorative wall effects
- > Instant start with flicker-free performance
- > Ideal for corridors, living rooms, hotels, and bedrooms
- > Modern architectural lighting for premium interiors
- > Long life LED performance with minimal maintenance
- > Suitable for both indoor and outdoor applications



Wall
Mount



Operating Voltage
110-300V AC



Aluminium
Housing



Surge Protection
Upto 4KV



Waterproof
Driver

Technical Details

Item Code	OOWLP2206WW
Wattage	3+3W
PKG.	20 Pcs.
Price ₹	1050.00

Led Type : COB

CCT : 3000K

LED Make : Bridgelux

CRI : 91

Body Colour : Black

Water Proof : IP65



AQUA LED
OUT DOOR WALL LIGHT



AQUA LED OUT DOOR WALL LIGHT



PRODUCT FEATURES AND BENEFIT

- > Premium aluminium housing for durability and efficient heat dissipation
- > Energy-efficient LED source for reduced power consumption
- > Soft ambient illumination for decorative wall effects
- > Instant start with flicker-free performance
- > Ideal for corridors, balconies, facades, and feature walls
- > Compact modern design for contemporary interiors and exteriors
- > Long-lasting LED performance with minimal maintenance
- > Enhances architectural textures and wall surfaces
- > Suitable for indoor and outdoor applications



Wall
Mount



Operating Voltage
110-300V AC



Aluminium
Housing



Surge Protection
Upto 4KV



Waterproof
Driver

Technical Details

Item Code	AOWLP2304WW
Wattage	2+2W
PKG.	20 Pcs.
Price ₹	675.00

Led Type : SMT

CCT : 3000K

LED Make : Bridgelux

CRI : 91

Body Colour : Grey

Water Proof : IP65



MIRA LED
OUT DOOR WALL LIGHT





MIRA LED OUT DOOR WALL LIGHT

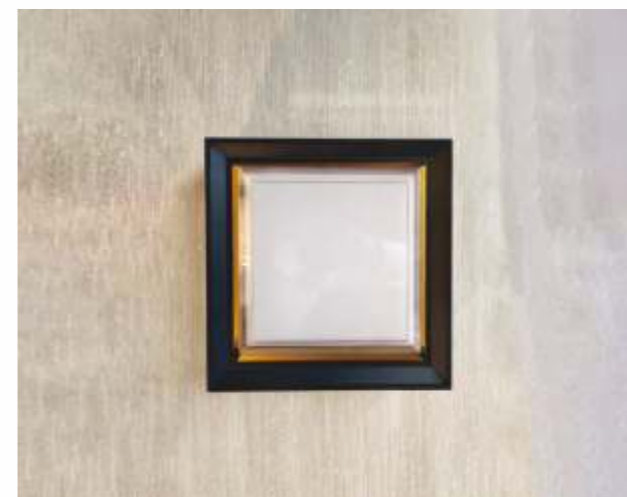

PRODUCT FEATURES AND BENEFIT

- > Modern square design for elegant outdoor wall décor
- > Premium aluminium housing for durability and corrosion resistance
- > Weather-resistant construction for reliable outdoor performance
- > Energy-efficient LED lighting for low power consumption
- > Soft diffused illumination for uniform light distribution
- > Ideal for building facades, entrances, and boundary walls
- > Minimalist architectural style for modern exteriors
- > Long-lasting LED performance with low maintenance
- > Enhances exterior aesthetics with ambient lighting
- > Suitable for both indoor and outdoor applications



Wall
Mount



Operating Voltage
110-300V AC



Aluminium
Housing



Surge Protection
Upto 4KV



Waterproof
Driver

Technical Details

Item Code	MOWLP2405WW
Wattage	5W
PKG.	20 Pcs.
Price ₹	1000.00

Led Type : SMT

CCT : 3000K

LED Make : Bridgelux

CRI : 91

Body Colour : Grey

Water Proof : IP65

VEGA LED OUT DOOR WALL LIGHT

The VEGA Wall Light is designed to enhance modern outdoor spaces with a perfect balance of style and functionality. Its sleek geometric design delivers a beautiful ambient glow that highlights architectural surfaces while creating a warm and welcoming atmosphere.

Engineered for durability and performance, VEGA is ideal for facades, garden walls, pathways, poolside areas, and luxury outdoor environments. The precisely controlled light distribution produces elegant wall-wash effects, transforming ordinary exteriors into striking architectural statements.





VEGA LED OUT DOOR WALL LIGHT



PRODUCT FEATURES AND BENEFIT

- > Modern Hexagon Design – Stylish geometric shape that enhances contemporary interiors.
- > Decorative 4-Way Light Effect – Creates elegant star-pattern wall illumination.
- > Premium Aluminum Body – Strong, corrosion-resistant housing for long durability.
- > Soft Ambient LED Glow – Produces warm and comfortable lighting for walls.
- > Energy-Efficient LED Technology – Consumes less power with longer life.
- > Architectural Wall Wash Lighting – Enhances textures and highlights walls.
- > Perfect for Accent Lighting – Ideal for hotels, lobbies, corridors, and living spaces.
- > Compact Surface-Mount Design – Easy installation on indoor and outdoor walls.



Wall
Mount



Operating Voltage
110-300V AC



Aluminium
Housing



Surge Protection
Upto 4KV



Waterproof
Driver

Technical Details

Item Code	VOWLP2506WW
Wattage	6W
PKG.	20 Pcs.
Price ₹	1200.00

Led Type : SMT

CCT : 3000K

LED Make : Bridgelux

CRI : 91

Body Colour : Grey

Water Proof : IP67



ARC LED
OUT DOOR WALL LIGHT





ARC LED OUT DOOR WALL LIGHT



PRODUCT FEATURES AND BENEFIT

- > Modern round LED wall light with elegant architectural design.
- > Up-down soft light effect enhances wall texture and ambience.
- > Durable aluminium housing for strength and heat dissipation.
- > Energy-efficient LED technology with low power consumption.
- > Weather-resistant construction (IP65 optional) suitable for indoor & outdoor use.
- > Uniform glare-free illumination for comfortable lighting.
- > Long LED life up to 50,000 hours with minimal maintenance.
- > Easy wall-mounted installation for residential and commercial spaces.
- > Ideal for facades, corridors, hotel walls, gardens, and entrances.



Wall
Mount



Operating Voltage
110-300V AC



Aluminium
Housing



Surge Protection
Upto 4KV



Waterproof
Driver

Technical Details

Item Code	AOWLP2605WW
Wattage	5W
PKG.	20 Pcs.
Price ₹	1000.00

Led Type : SMT

CCT : 3000K

LED Make : Bridgelux

CRI : 91

Body Colour : Grey

Water Proof : IP65



ECLIPSE LED OUT DOOR WALL LIGHT

The ECLIPSE Wall Light is designed to elevate modern architectural spaces with a refined balance of elegance and performance. Its minimalist cylindrical form delivers a beautifully controlled up-down light effect, enhancing vertical surfaces and creating a sophisticated ambient atmosphere.

Perfect for luxury interiors, hotel lobbies, corridors, villas, and commercial spaces, ECLIPSE highlights architectural textures while adding depth and visual interest to the environment.



ECLIPSE LED OUT DOOR WALL LIGHT



PRODUCT FEATURES AND BENEFIT

- > Up & Down Lighting – Creates elegant dual-direction wall illumination.
- > Aluminium Body – Durable, rust-resistant housing.
- > Modern Design – Sleek look for contemporary spaces.
- > Energy Efficient LED – Bright light with low power consumption.
- > Architectural Accent Light – Perfect for decorative wall highlighting.
- > Long Lifespan – Reliable performance with minimal maintenance.



Wall
Mount



Operating Voltage
110-300V AC



Aluminium
Housing



Surge Protection
Upto 4KV



Waterproof
Driver

Technical Details

Item Code	EOWLP2702WW
Wattage	2X1 = 2W
PKG.	20 Pcs.
Price ₹	750.00

Led Type : SMT

CCT : 3000K

LED Make : Bridgelux

CRI : 91

Body Colour : Silver

Water Proof : IP65



NOVA LED
OUTDOOR WALL LIGHT

BIOCON Pro
LED LIGHTING

NOVA LED

OUTDOOR WALL LIGHT



PRODUCT FEATURES AND BENEFIT

- > Sleek modern cube design for contemporary architectural lighting
- > Premium aluminium housing for durability and efficient heat dissipation
- > Energy-efficient LED light source for low power consumption
- > Focused beam lighting ideal for accent illumination
- > Corrosion-resistant body for long-lasting outdoor use
- > Perfect for facades, pathways, and exterior walls
- > Compact and minimalist design for modern buildings
- > Stable and reliable performance in outdoor conditions
- > Enhances architectural features with focused lighting
- > Suitable for both indoor and outdoor applications



Wall
Mount



Operating Voltage
110-300V AC



Aluminium
Housing



Surge Protection
Upto 4KV



Waterproof
Driver

Technical Details

Item Code	NOWLP2802WW
Wattage	2X1 = 2W
PKG.	20 Pcs.
Price ₹	700.00

Led Type : SMT

CCT : 3000K

LED Make : Bridgelux

CRI : 91

Body Colour : Silver

Water Proof : IP65

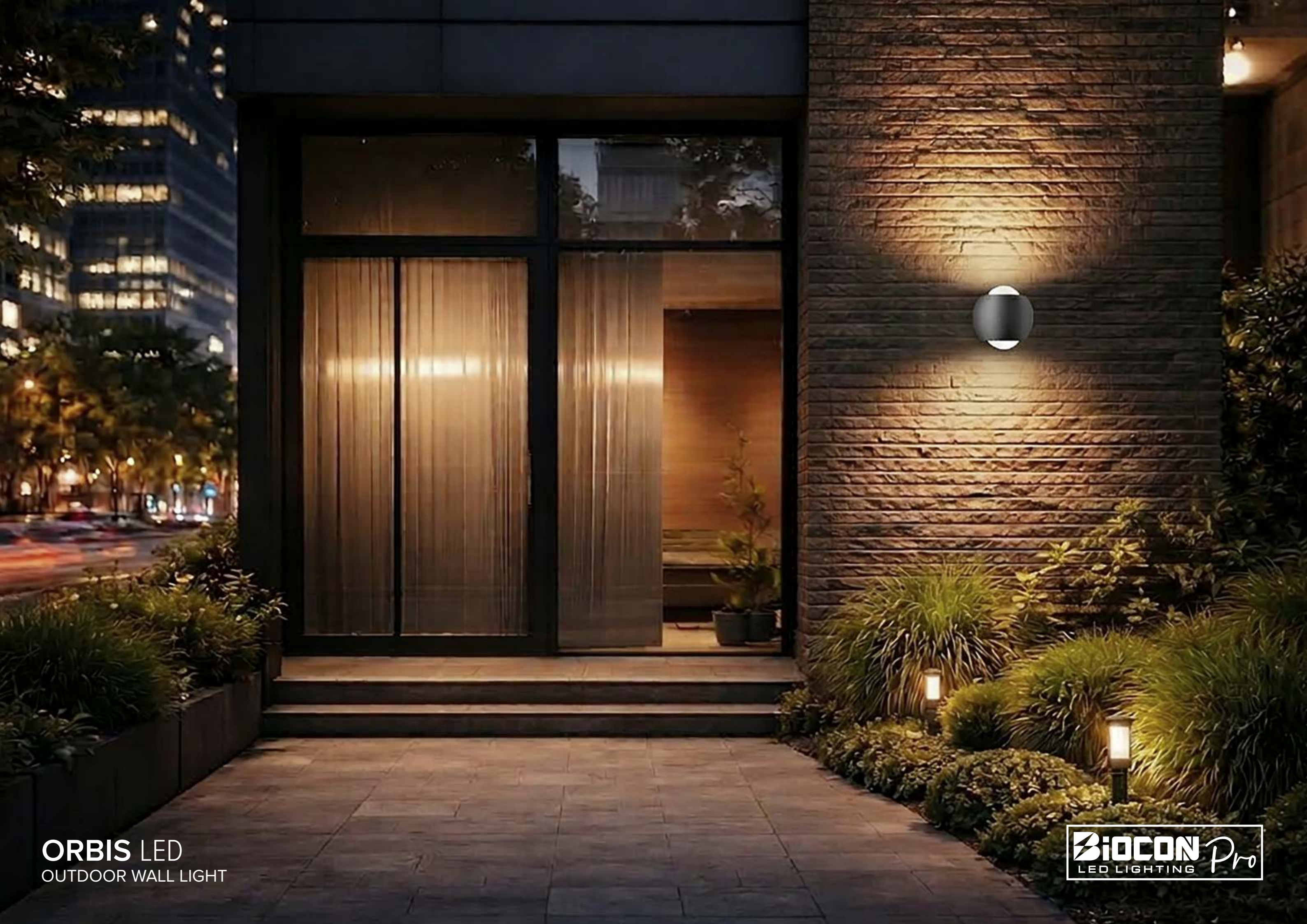

ORBIS LED
OUTDOOR WALL LIGHT

BIOCON Pro
LED LIGHTING



ORBIS LED OUTDOOR WALL LIGHT



PRODUCT FEATURES AND BENEFIT

- > Dual Beam Wall Light – Up & down lighting for elegant wall illumination.
- > Minimalist Modern Design – Compact cylindrical style for contemporary interiors.
- > Premium Aluminum Housing – Durable body with excellent heat dissipation.
- > Architectural Light Effect – Creates stylish vertical light patterns on walls.
- > Energy-Efficient LED Source – Low power consumption with long life.
- > Soft Ambient Lighting – Ideal for creating warm and comfortable atmospheres.
- > Perfect for Decorative Walls – Suitable for hotels, corridors, lobbies, and homes.
- > Easy Surface Wall Installation – Compact design for hassle-free mounting.



Wall
Mount



Operating Voltage
110-300V AC



Aluminium
Housing



Surge Protection
Upto 4KV



Waterproof
Driver

Technical Details

Item Code	OOWLP2902WW
Wattage	2X1 = 2W
PKG.	20 Pcs.
Price ₹	675.00

Led Type : SMT

CCT : 3000K

LED Make : Bridgelux

CRI : 91

Body Colour : Silver

Water Proof : IP65

RHOMBUS LED OUTDOOR WALL LIGHT

The RHOMBUS Wall Light brings a distinctive geometric design to modern outdoor spaces. Its unique form creates a striking multi-directional light pattern, casting elegant beams that enhance walls and architectural surfaces.

Designed to complement contemporary homes, gardens, pathways, and exterior facades, RHOMBUS transforms outdoor environments with a warm and visually captivating lighting effect. The balanced illumination adds depth, character, and a sophisticated ambiance to any setting.

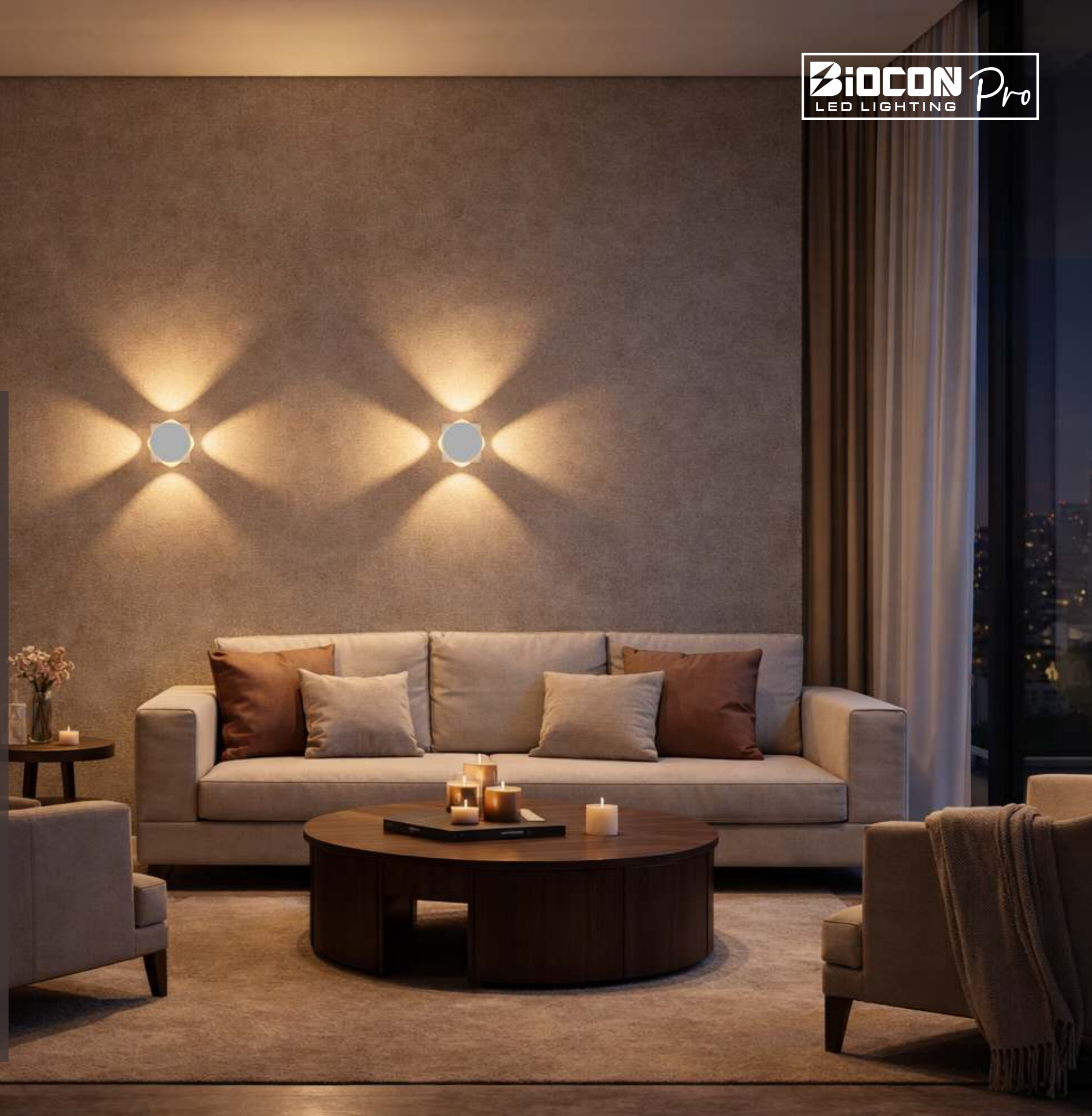



RHOMBUS LED OUTDOOR WALL LIGHT



PRODUCT FEATURES AND BENEFIT

- > 4-way light distribution creates a decorative architectural lighting effect.
- > Modern square design enhances contemporary interiors and facades.
- > High-efficiency LED source for bright yet energy-saving illumination.
- > Premium aluminium body for durability and excellent heat dissipation.
- > Soft glare-free lighting for comfortable ambience.
- > Suitable for indoor and outdoor walls like lobbies, corridors, and facades.
- > Long operational life ensuring low maintenance.
- > Quick and easy wall installation for residential and commercial spaces.



Wall
Mount



Operating Voltage
110-300V AC



Aluminium
Housing



Surge Protection
Upto 4KV



Waterproof
Driver

Technical Details

Item Code	ROWLP3004WW
Wattage	4W
PKG.	20 Pcs.
Price ₹	1000.00

Led Type : SMT

CCT : 3000K

LED Make : Bridgelux

CRI : 91

Body Colour : Silver

Water Proof : IP65



BRELLA LED
GATE LIGHT

BIOCON Pro
LED LIGHTING



BRELLA LED GATE LIGHT



PRODUCT FEATURES AND BENEFIT

- > Elegant gate & pillar lighting for premium outdoor aesthetics
- > 360° or directional illumination for enhanced visibility & ambiance
- > Weatherproof construction with IP65 / IP66 protection
- > High-quality materials for durability in outdoor conditions
- > Soft, warm lighting for welcoming entrance appeal
- > Energy-efficient LED for long-lasting performance
- > Modern design to complement contemporary architecture



Gate
Mount



Operating Voltage
110-300V AC



Aluminium
Housing



Surge Protection
Upto 4KV

Technical Details

Item Code	BGL2020WH
Wattage	20W
PKG.	18 Pcs.
Price ₹	2200.00

Led Type : SMD
LM/W : 100LM/W

CRI : 80
CCT : 3000K

Voltage : AC110~300V
Current : 280~300mA



ZION LED
STEP LIGHT

BIOCON Pro
LED LIGHTING



ZION LED STEP LIGHT



PRODUCT FEATURES AND BENEFIT

- > Compact recessed step light for subtle architectural lighting
- > Low-glare output for safe and comfortable visibility
- > Designed for uniform step illumination without harsh brightness
- > Energy-efficient LED for continuous low power usage
- > Durable construction suitable for indoor & outdoor applications
- > Weather-resistant design with IP54 protection
- > Soft, directional light to highlight pathways and edges



Step
Mount



Operating Voltage
110-300V AC



Aluminium
Housing



Surge Protection
Upto 4KV

Technical Details

Item Code	ZSL2003WH
Wattage	3W
Cutout	40 X 40 MM
PKG.	50 Pcs.
Price ₹	550.00

Led Type : COB
LM/W : 100LM/W
CCT : 3000K

Angle : 24°
CRI : 80
Safety Type : IP54

Voltage : AC110~300V
Current : 280-300mA



BRIGHTON COB
NEON ROPE LIGHT

BIOCON Pro
LED LIGHTING



BRIGHTON COB

NEON ROPE LIGHT

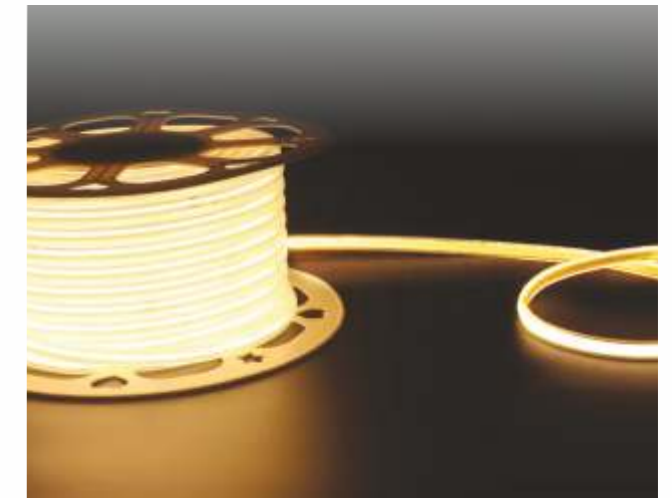
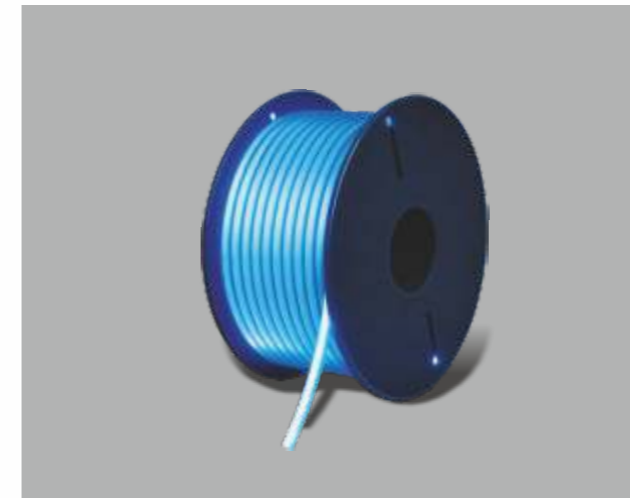

PRODUCT FEATURES AND BENEFIT

- > Flexible neon rope design for smooth continuous lighting lines
- > Uniform neon glow without visible LED dots
- > Energy-efficient LED technology for low power consumption
- > Highly flexible structure for bending into shapes and designs
- > Durable silicone/PVC coating for long-lasting performance
- > Water-resistant construction suitable for indoor and outdoor use
- > Ideal for architectural outlines, signage, and decorative lighting
- > Low heat emission for safe long-hour operation
- > Long LED lifespan reducing maintenance and replacements
- > Perfect for facades, cove lighting, landscape edges, and event decor

 Flexible Mount	 10mm Double Copper PCB	 Cut in Every 1 Meter	 45 Meters Roll	 800lm per meter
---	---	---	---	--

Technical Details

Item Code	BCRL2710WH	BCRL2710BL
Voltage	220-240V	220-240V
PKG.	1 ROLL	1 ROLL
Price ₹	8500.00	10000.00
Colour Temp	WH/WW/NW	BL/GR/PI/RD/AM/IB
MTR on Reel	45	45

Led Type : Rope Light
LM/W : 100LM/W

Voltage : AC110~300V
Current : 280-300mA

TWINKLE
ROPE LIGHT





TWINKLE LED

ROPE LIGHT



PRODUCT FEATURES AND BENEFIT

- > Flexible LED rope design for decorative lighting applications
- > Bright and uniform illumination along the entire length
- > Energy-efficient LED technology for low power consumption
- > Durable transparent PVC coating for protection and flexibility
- > Easy bending and shaping for creative lighting layouts
- > Ideal for building outlines, ceilings, and decorative lighting
- > Perfect for events, signage, and festive installations
- > Low heat emission for safe continuous operation
- > Long LED lifespan with minimal maintenance
- > Suitable for indoor and outdoor decorative lighting



Flexible Mount



11mm Double Copper PCB



Cut in Every 1 Meter



45 Meters Roll

Technical Details

Item Code	TRL262835WH	TRL262835GR
Voltage	220-240V	220-240V
PKG.	1 ROLL	1 ROLL
Price ₹	4500.00	5000.00
Colour Temp	WH/WW/BL	GR/PI/RD/AM/IB
MTR on Reel	45	45

Led Type : Rope Light
LM/W : 100LM/W

Voltage : AC110~300V
Current : 280-300mA



SPARK LED
STRIP LIGHT

BIOCON Pro
LED LIGHTING



SPARK PRO

LED STRIP LIGHT



PRODUCT FEATURES AND BENEFIT

- > Flexible LED strip design for seamless lighting installation
- > High-density LEDs for bright and uniform illumination
- > Energy-efficient lighting for reduced power consumption
- > Slim profile ideal for concealed lighting applications
- > Easy cut and installation for customized lengths
- > Perfect for cove lighting, cabinets, and architectural accents
- > Strong adhesive backing for quick mounting
- > Ideal for residential, commercial, and decorative lighting

Flexible
Mount

Operating Voltage
12V DC

5 Meters
Roll

Technical Details

Item Code	SSPL212835WH	SSPL212835BL
Voltage	12V	12V
PKG.	500 Mtrs.	500 Mtrs.
Price ₹	90.00	100.00
Colour Temp	WH/WW/NW	BL/GR/PI/RD/AM/IB
MTR on Reel	5	5

Led Type : Strip Light
LM/W : 100LM/W

Voltage : 12V
Safety Type : IP20



SAFE PRO
HEAVY STRIP SMPS DRIVER







SAFE PRO

HEAVY STRIP SMPS DRIVER



PRODUCT FEATURES AND BENEFIT

- > Stable 12V DC output for LED strip lighting applications
- > High-efficiency power conversion for energy-saving performance
- > Compact and durable design for easy installation & concealment
- > Overload, short-circuit & over-voltage protection system
- > Consistent voltage supply for flicker-free lighting
- > Wide input voltage range for reliable operation
- > Advanced circuitry for long-lasting performance

 Operating Voltage 12V DC	 Aluminium Housing	 Surge Protection Upto 4KV
--	---	---

Technical Details

Item Code	SPSD2302A	SPSD2305A	SPSD2310A	SPSD2316.5A
Output V/I	12V/2 AMPS	12V/5 AMPS	12V/10 AMPS	12V/16.5 AMPS
PKG.	200 Pcs.	100 Pcs.	100 Pcs.	50 Pcs.
Price ₹	350.00	475.00	720.00	1250.00

Type : SMPS Driver

Safety Type : IP54

BIOGLOW

Aluminium Profile fitting

Aluminium Profile fitting



ARC RECESSED PROFILE NEW

ITEM CODE	LENGTH	DIMENSION	BODY COLOUR	PRICE ₹	PKG
AAPBK2002M	2 Mtr	17X7 MM	BLACK	300.00	100

PRICE PER 2 MTR



ARC RECESSED PROFILE NEW

ITEM CODE	LENGTH	DIMENSION	BODY COLOUR	PRICE ₹	PKG
AAPAG2002M	2 Mtr	17X7 MM	SILVER	270.00	100

PRICE PER 2 MTR



ARC SURFACE PROFILE NEW

ITEM CODE	LENGTH	DIMENSION	BODY COLOUR	PRICE ₹	PKG
AAPSFAG2002M	2 Mtr	17X7 MM	SILVER	240.00	100

PRICE PER 2 MTR



VEO RECESSED PROFILE NEW

ITEM CODE	LENGTH	DIMENSION	BODY COLOUR	PRICE ₹	PKG
VAPAG2102M	2 Mtr	23X10 MM	SILVER	375.00	100

PRICE PER 2 MTR



VEO SURFACE PROFILE NEW

ITEM CODE	LENGTH	DIMENSION	BODY COLOUR	PRICE ₹	PKG
VAPSFAG2102M	2 Mtr	23X10 MM	SILVER	350.00	100

PRICE PER 2 MTR



TRON CORNER PROFILE NEW

ITEM CODE	LENGTH	DIMENSION	BODY COLOUR	PRICE ₹	PKG
TAPCAG2002M	2 Mtr	16X16 MM	SILVER	350.00	30

PRICE PER 2 MTR



SKY RECESSED PROFILE NEW

ITEM CODE	LENGTH	DIMENSION	BODY COLOUR	PRICE ₹	PKG
SAPAG2202M	2 Mtr	12X10 MM	SILVER	260.00	50

PRICE PER 2 MTR



India's No. 1 PVC Tape Brand

Every connection needs protection you can trust. Designed with advanced adhesive strength and flame-resistant and water proof material, our insulation tape provides a secure hold that stands up to heat, water, wear, and time.



FR SELF
ADHESIVE
PVC ELECTRICAL INSULATION TAPE



WIRES THAT RESIST FIRES

**HIGH CONDUCTIVITY.
LOW HEAT GENERATION.
MAXIMUM SAFETY.**

Engineered for performance and built for safety, our wires deliver consistent power with minimal loss. Designed with high-grade copper and advanced insulation, they reduce heat, prevent risks, and ensure long-lasting reliability.

Because when power flows, safety should too.

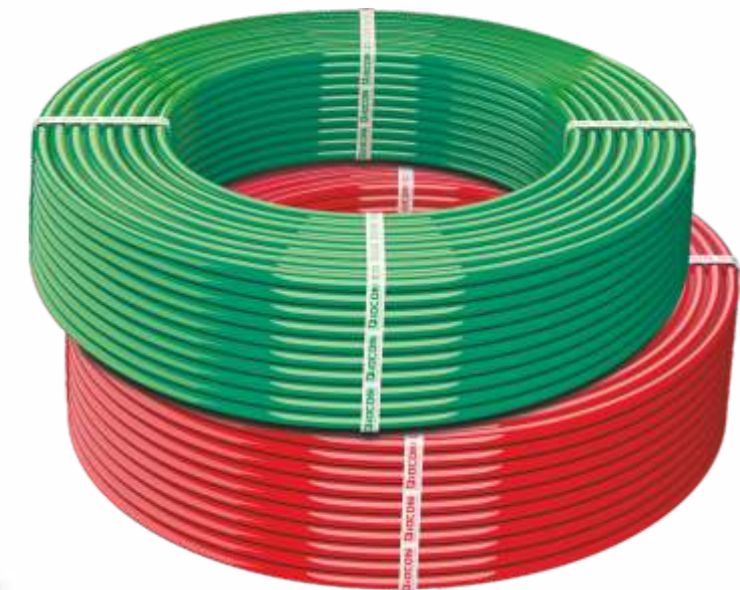

ENGINEERED FOR PRECISION PROTECTION

Power you can trust.
Protection you can see.



B-Trip
10kA MCB



Beauty that amuses your senses.

An ultimate reflection of aesthetics coupled with style and absolute perfection, these plates suit every decor, blending seamlessly. Offering a wide array of styles, designs and materials, these classic designs lend an urbane look to your spaces leaving an impression that's timeless.



EXPERIENCE
LUXURY
LIKE NEVER
BEFORE

PLATINUM
MODULAR PLATES



BIOCON ELECTRIC [P] LIMITED

BRANCHES

DELHI

4/24/1B,
J.R. Complex Gate No. 4,
Mandoli Main Road,
Trans Yamuna
Delhi-110093 (INDIA)

MAHARASHTRA

12, VK Industrial Complex,
Bilal Pada,
Vasai East-401208
Suburban,
Mumbai (INDIA)

KARNATAKA

No. 214, 2nd Floor,
Shankalp Business Bay Tower,
Opp. to Eta Garden Apartment,
Magadi Main Road,
Bengaluru-560023 (INDIA)

UTTAR PRADESH

B-13, Sector-63,
Noida-201301 (UP)

PUNJAB
JAMMU

KERALA
KASHMIR

BIHAR
TELANGANA

ASSAM
WEST BENGAL

ODISHA
TAMIL NADU

NETWORKS

OFFICES | SHOWROOMS | DISPLAY CENTRE

Karnataka | Tamil Nadu | Telangana | Andhra Pradesh | Kerala
Rajasthan | Gujarat | Madhya Pradesh | Chhattisgarh
Himachal Pradesh | Uttarakhand | Maharashtra | Punjab
Haryana | Uttar Pradesh | Bihar | Jammu & Kashmir
West Bengal | Odisha | Jharkhand | North East.



Website : www.bioconelectric.com
Email : Info@bioconelectric.in
Toll Free No. : 1800-120-555 444



Scan this QR Code
on your mobile to
check out the website