

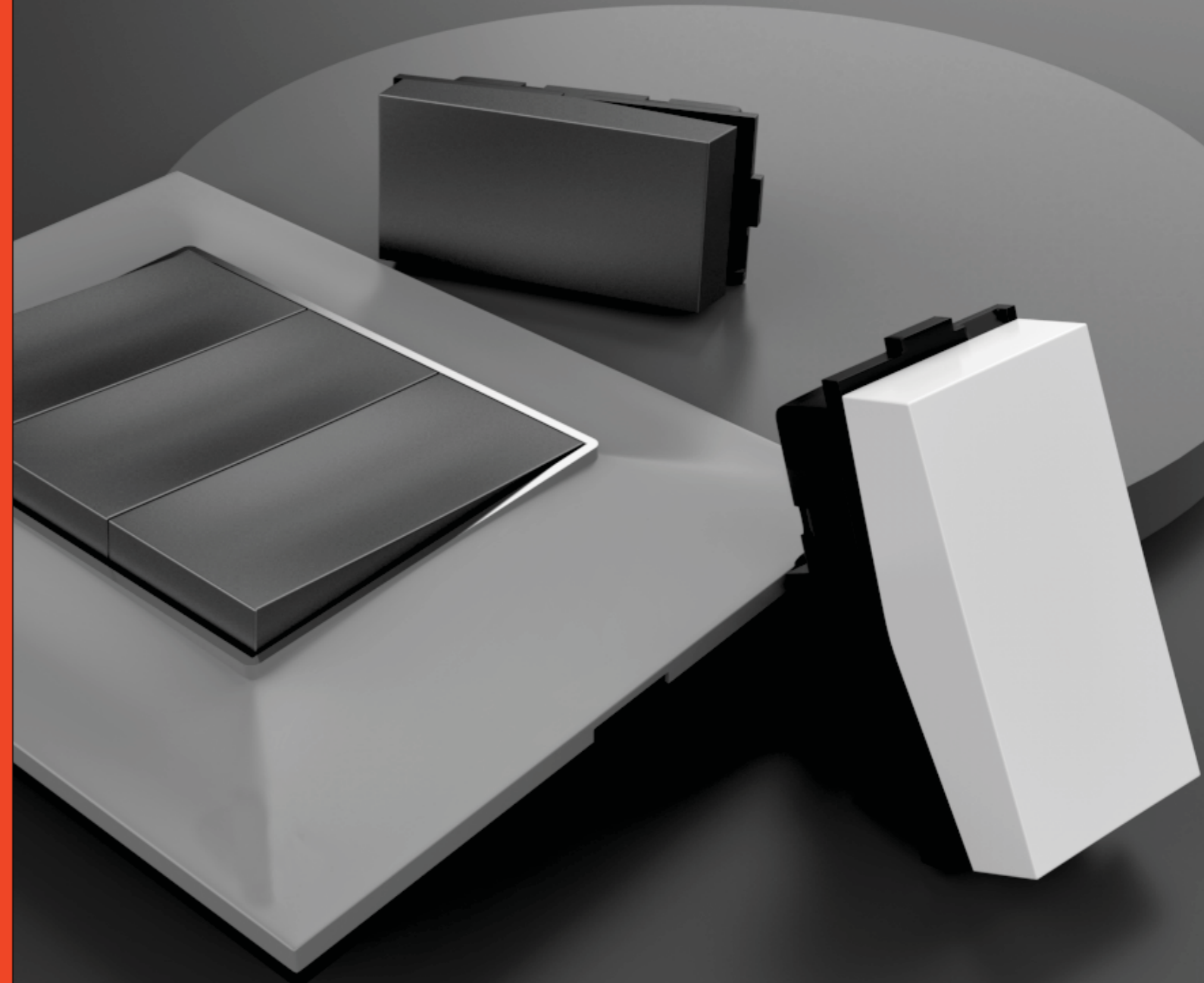

SCAN THIS QR CODE ON YOUR MOBILE  
TO CHECK OUT THE RANGE OF  
BIOCON PRODUCTS



# Endless Possibilities for Modern Home

**BIOCON ELECTRIC [P] LIMITED**  
Gala No. 12, V.K. Ind. Complex, K.T. Ind. Park-2, Bilalpada,  
Waliv, Vasai (E), 401208, Maharashtra, INDIA  
Customer Care Toll Free No. :1800-120-555444



follow us :

2023 Product & Pricing  
Volume - 1

# CONTENTS

BEE5 ACCESSORIES	1 - 4
BEE5 GLASSO PLATES	5 - 8
BEE5 BLING PLATES	9 - 10
BEE5 B-FIT PLATES	11 - 12
BEE5 COLOUR PLATES	13 - 14
ROSSA ACCESSORIES	15 - 18
ROSSA B-RADIUS PLATES	19 - 19
ROSSA B-WOOD PLATES	20 - 20
ROSSA PLATE COLOURS	21 - 22
ROSSA SURFACE ACCESSORIES	23 - 24
ROSSA SILVEREX GANG BOX	25 - 26
BOXIT SURFACE BOX	27 - 27
CONCEALED METAL BOX	28 - 28
LAMP HOLDER & PLUGTOP	29 - 29
MULTI PLUG, DOOR BELLS,	30 - 30
FLEXBOX & POWER STRIP	



# High PERFORMANCE SWITCHES



**KNOB**  
SECURED  
OPERATIONS



**SPARK SHIELD**  
TO TRANSCEND  
THE SPARK  
INSIDE THE PIECE



**BI-METAL RIVET**  
SILVER METAL FOR  
BEST CONDUCTIVITY



**THERMOSET MATERIAL**  
EXTREMELY HIGH RESISTANT &  
DOES NOT MELT ON HEATING

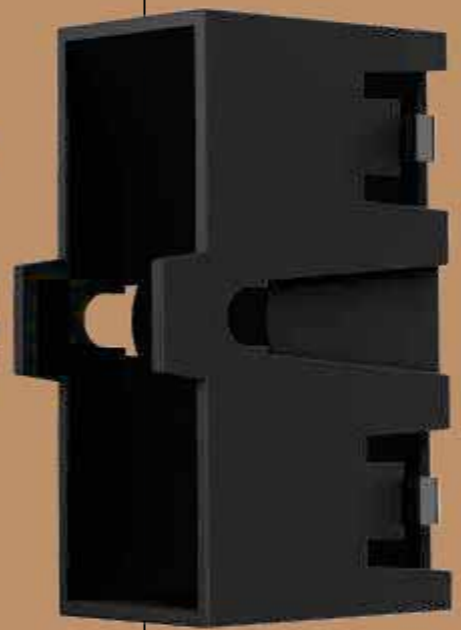

**COPPER CONTACT PLATE**  
HEAVY GAUGE  
COPPER BI  
METAL CONTACT  
SILVER COATING

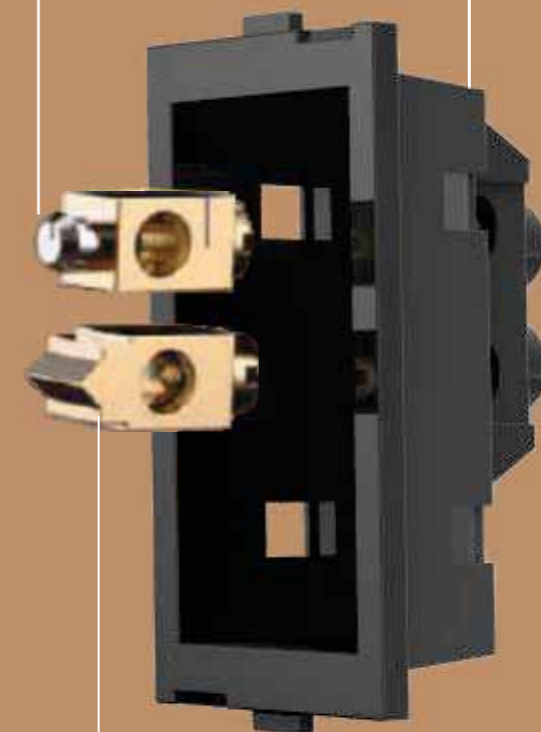

**HOUSING SUPPORT**  
BACK PIECE  
FR GRADE POLYCARBONATE



**ROCKER BALL**  
Brass With Spring  
for long life operations



**TERMINAL CONTACT**  
BRASS EXTRUSION  
ROD (HEAVY DUTY)

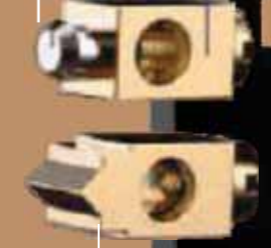

**WIRE SCREW**  
BRASS EXTRUSION  
ROD (HEAVY DUTY)



HEAVY DUTY BRASS PARTS



MODULAR ACCESSORIES

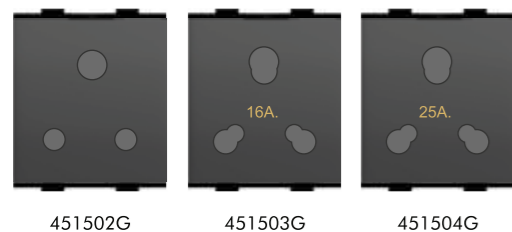
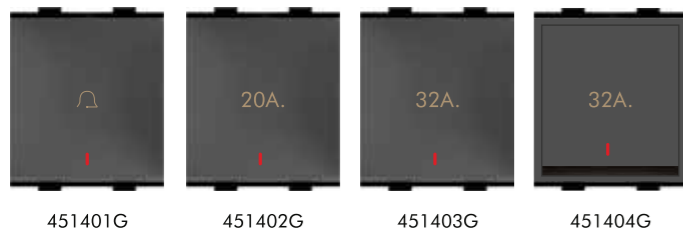
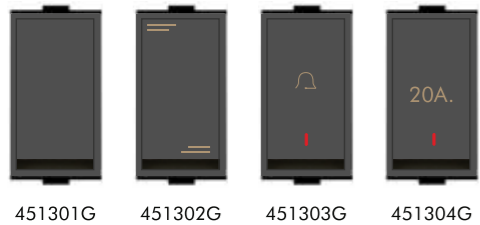
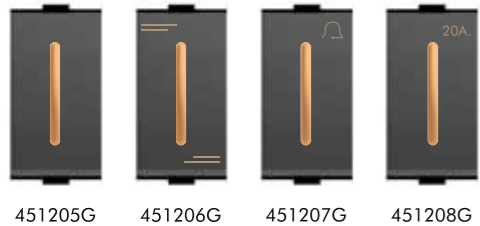
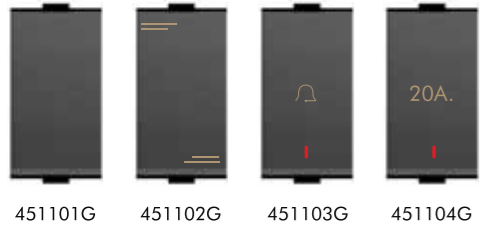

CODE	ITEM	MRP ₹ METALLIC GREY	PKG.
<b>BEE-FIVE 10AX. - 20A. SWITCHES 240V. AC 1M</b>			
451001G	10AX. 1 WAY SWITCH	62.00	20
451002G	10AX. 2 WAY SWITCH	120.00	20
451003G	10AX. 1 WAY SWITCH WITH INDI.	120.00	20
451004G	BELL PUSH SWITCH WITH INDI.	145.00	20
451005G	20A. 1 WAY SWITCH WITH INDI.	175.00	20
<b>TRIQ 10AX. - 20A. SWITCHES 240V. AC 1M</b>			
451101G	10AX. 1 WAY SWITCH	65.00	20
451102G	10AX. 2 WAY SWITCH	135.00	20
451103G	BELL PUSH SWITCH WITH INDI.	140.00	20
451104G	20A. 1 WAY SWITCH WITH INDI.	190.00	20
<b>CROMZ (SILVER) 10AX. - 20A. SWITCHES 240V. AC 1M</b>			
451201G	10AX. 1 WAY SWITCH	70.00	20
451202G	10AX. 2 WAY SWITCH	155.00	20
451203G	BELL PUSH SWITCH	195.00	20
451204G	20A. 1 WAY SWITCH	225.00	20
<b>CROMZ (COPPER) 10AX. - 20A. SWITCHES 240V. AC 1M</b>			
451205G	10AX. 1 WAY SWITCH	80.00	20
451206G	10AX. 2 WAY SWITCH	165.00	20
451207G	BELL PUSH SWITCH	195.00	20
451208G	20A. 1 WAY SWITCH	225.00	20
<b>LEVEL 10AX. - 20A. SWITCHES 240V. AC 1M</b>			
451301G	10AX. 1 WAY SWITCH	65.00	20
451302G	10AX. 2 WAY SWITCH	140.00	20
451303G	BELL PUSH SWITCH WITH INDI.	190.00	20
451304G	20A. 1 WAY SWITCH WITH INDI.	220.00	20
<b>BEE-FIVE SUMO &amp; DP. SWITCHES 2M</b>			
451401G	BELL PUSH SWITCH WITH INDI.	215.00	10
451402G	20A. 1 WAY SWITCH WITH INDI.	250.00	10
451403G	32A. SUMO DP. SWITCH WITH INDI.	375.00	10
451404G	32A. LEVEL DP. SWITCH WITH INDI.	390.00	10
<b>BEE-FIVE 6A &amp; 6/16A. SOCKETS 240V. AC 2M</b>			
451502G	6A 3 PIN SOCKET WITH SAFETY SHUTTER	110.00	10
451503G	6/16A 3 PIN SOCKET WITH SAFETY SHUTTER	205.00	10
451504G	25A 3 PIN SOCKET WITH SAFETY SHUTTER	250.00	10



CODE	ITEM	MRP ₹ METALLIC GREY	PKG.
<b>EME FAN REGULATOR FULL ROTARY</b>			
451603G	BLAZE EME 4 STEP FAN REGU.	375.00	10
451604G	BLAZE EME 5 STEP FAN REGU.	430.00	10
451605G	CANDY EME 4 STEP FAN REGU.	375.00	10
451606G	CANDY EME 5 STEP FAN REGU.	430.00	10
<b>ANCILLARIES</b>			
451701G	BLANK PLATE 1M	28.00	50
451702G	KITKAT FUSE (10A & 16A) 1M	155.00	10
451703G	NEON INDICATOR 1M	105.00	10
451704G	MINI TV SOCKET 1M (WITH CORD - GRIP)	130.00	10
451705G	ELECTRIC BUZZER 2M	375.00	10
<b>IT PRODUCTS</b>			
451801G	RJ11 TEL JACK SINGLE 1M (WITH SHUTTER)	140.00	10
451802G	USB CHARGER 1M (WITH SINGLE USB PORT)	800.00	10
451803G	RJ45 MODEM JACK ( AT & T ) CAT -6	600.00	10
<b>BEE-FIVE HOTEL &amp; HOSPITALITY RANGE</b>			
451901G	32A DP MAIN SWITCH KEYTAG	550.00	10
451902G	TAGKEY TAG RING ONLY	110.00	20
451903G	DND / MAKE MY ROOM IND UNIT OUTSIDE ROOM 2M (PRICES ARE WITHOUT FRAME)	650.00	1
451904G	DND / MAKE MY ROOM WITH 2 SWITCH UNIT INSIDE ROOM WITH DOOR BELL CUT OFF WIRING 3M (PRICES ARE WITHOUT FRAME)	750.00	1
<b>LED FOOT LIGHT / LED NIGHT LAMP</b>			
452001G	STEP MARKER LIGHT 2M (WHITE)	400.00	10
452011G	STEP MARKER LIGHT 2M (W/ WHITE)	400.00	10
452002G	STEP MARKER LIGHT 3M (WHITE)	475.00	10
452012G	STEP MARKER LIGHT 3M (W/ WHITE)	475.00	10
452003G	NIGHT LAMP 2M (COOL WHITE)	350.00	10
<b>MCB'S &amp; MOTOR STARTER</b>			
452201G	SINGLE POLE MCB 6A.	280.00	12
452211G	SINGLE POLE MCB 10A.	280.00	12
452221G	SINGLE POLE MCB 16A.	280.00	12
452231G	SINGLE POLE MCB 20A.	280.00	12
452241G	SINGLE POLE MCB 25A.	280.00	12
452251G	SINGLE POLE MCB 32A.	280.00	12
452202G	DOUBLE POLE MCB 6A.	600.00	06
452212G	DOUBLE POLE MCB 10A.	600.00	06
452222G	DOUBLE POLE MCB 16A.	600.00	06
452232G	DOUBLE POLE MCB 20A.	600.00	06
452242G	DOUBLE POLE MCB 25A.	600.00	06
452252G	DOUBLE POLE MCB 32A.	600.00	06
452101G	SINGLE PHASE MOTOR STARTER 25A.	575.00	10

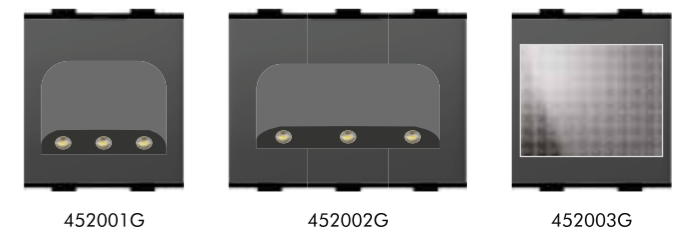
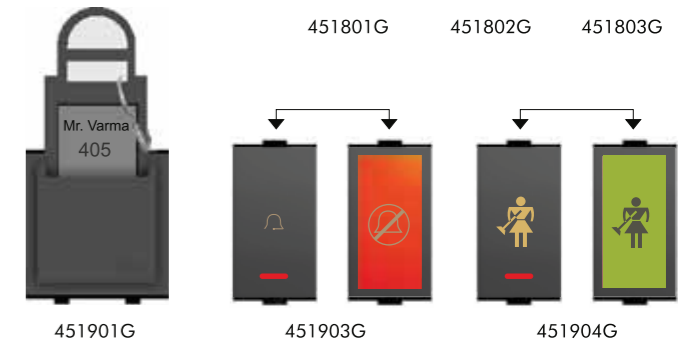
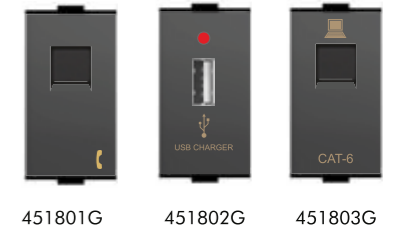
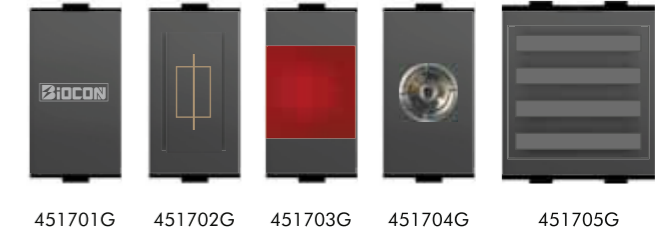
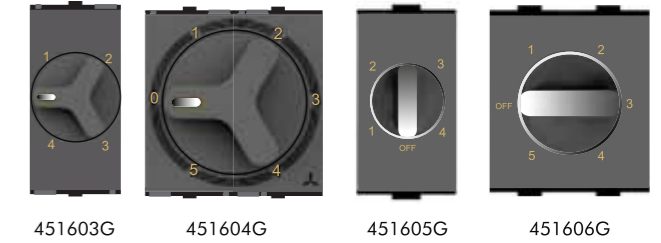



MODULAR ACCESSORIES

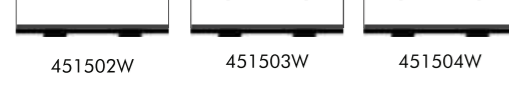
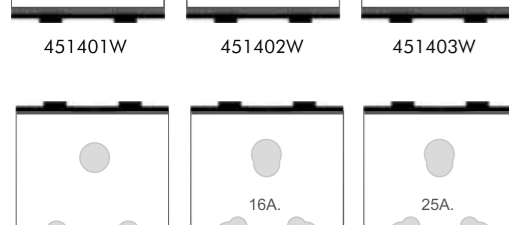
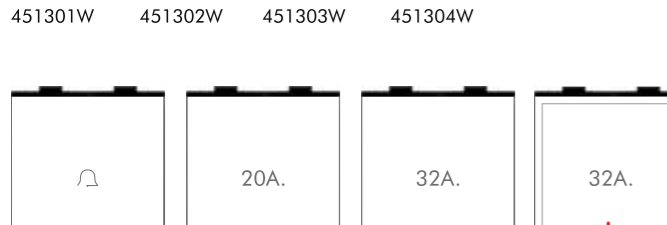
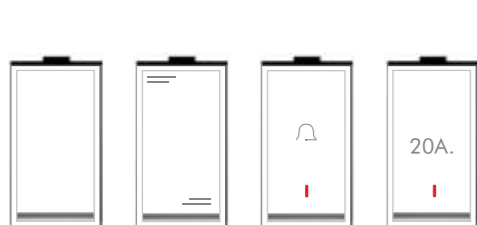
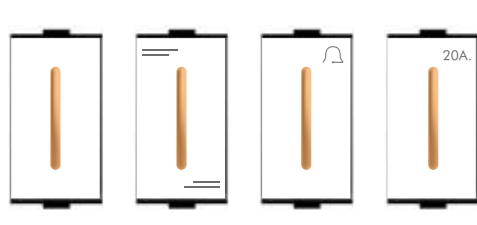
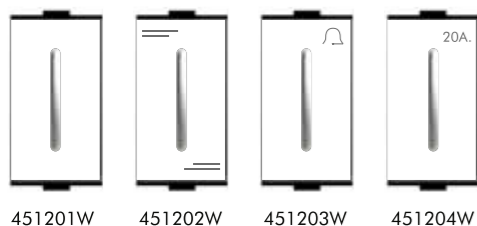
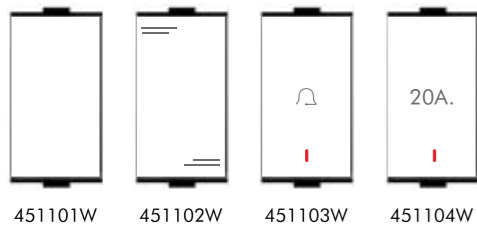
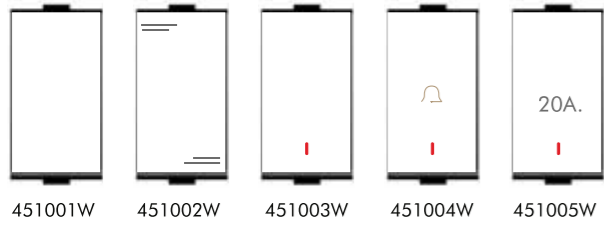

**BEE-FIVE 10AX. - 20A. SWITCHES 240V. AC 1M**

CODE	ITEM	MRP ₹ WHITE	PKG.
451001W	10AX. 1 WAY SWITCH	50.00	20
451002W	10AX. 2 WAY SWITCH	110.00	20
451003W	10AX. 1 WAY SWITCH WITH INDI.	105.00	20
451004W	BELL PUSH SWITCH WITH INDI.	120.00	20
451005W	20A. 1 WAY SWITCH WITH INDI.	150.00	20

**TRIQ 10AX. - 20A. SWITCHES 240V. AC 1M**

CODE	ITEM	MRP ₹ WHITE	PKG.
451101W	10AX. 1 WAY SWITCH	50.00	20
451102W	10AX. 2 WAY SWITCH	110.00	20
451103W	BELL PUSH SWITCH WITH INDI.	125.00	20
451104W	20A. 1 WAY SWITCH WITH INDI.	150.00	20

**CROMZ (SILVER) 10AX. - 20A. SWITCHES 240V. AC 1M**

CODE	ITEM	MRP ₹ WHITE	PKG.
451201W	10AX. 1 WAY SWITCH	55.00	20
451202W	10AX. 2 WAY SWITCH	140.00	20
451203W	BELL PUSH SWITCH	175.00	20
451204W	20A. 1 WAY SWITCH	200.00	20

**CROMZ (COPPER) 10AX. - 20A. SWITCHES 240V. AC 1M**

CODE	ITEM	MRP ₹ WHITE	PKG.
451205W	10AX. 1 WAY SWITCH	65.00	20
451206W	10AX. 2 WAY SWITCH	150.00	20
451207W	BELL PUSH SWITCH	180.00	20
451208W	20A. 1 WAY SWITCH	200.00	20

**LEVEL 10AX. - 20A. SWITCHES 240V. AC 1M**

CODE	ITEM	MRP ₹ WHITE	PKG.
451301W	10AX. 1 WAY SWITCH	50.00	20
451302W	10AX. 2 WAY SWITCH	110.00	20
451303W	BELL PUSH SWITCH WITH INDI.	135.00	20
451304W	20A. 1 WAY SWITCH WITH INDI.	170.00	20

**BEE-FIVE SUMO & DP. SWITCHES 2M**

CODE	ITEM	MRP ₹ WHITE	PKG.
451401W	BELL PUSH SWITCH WITH INDI.	185.00	10
451402W	20A. 1 WAY SWITCH WITH INDI.	215.00	10
451403W	32A. SUMO DP. SWITCH WITH INDI.	300.00	10
451404W	32A. LEVEL DP. SWITCH WITH INDI.	340.00	10

**BEE-FIVE 6A & 6/16A. SOCKETS 240V. AC 2M**

CODE	ITEM	MRP ₹ WHITE	PKG.
451502W	6A 3 PIN SOCKET WITH SAFETY SHUTTER	95.00	10
451503W	6/16A 3 PIN SOCKET WITH SAFETY SHUTTER	195.00	10
451504W	25A 3 PIN SOCKET WITH SAFETY SHUTTER	220.00	10



**EME FAN REGULATOR FULL ROTARY**

CODE	ITEM	MRP ₹ WHITE	PKG.
451603W	BLAZE EME 4 STEP FAN REGU.	350.00	10
451604W	BLAZE EME 5 STEP FAN REGU.	400.00	10
451605W	CANDY EME 4 STEP FAN REGL.	350.00	10
451606W	CANDY EME 5 STEP FAN REGU.	400.00	10

**ANCILLARIES**

CODE	ITEM	MRP ₹ WHITE	PKG.
451701W	BLANK PLATE 1M	22.00	50
451702W	KITKAT FUSE (10A & 16A) 1M	135.00	10
451703W	NEON INDICATOR 1M	95.00	10
451704W	MINI TV SOCKET 1M (WITH CORD -WRIP)	110.00	10
451705W	ELECTRIC BUZZER 2M	325.00	10

**IT PRODUCTS**

CODE	ITEM	MRP ₹ WHITE	PKG.
451801W	RJ11 TEL JACK SINWLE 1M (WITH SHUTTER)	110.00	10
451802W	USB CHARGER 1M (WITH SINWLE USB PORT)	700.00	10
451803W	RJ45 MODEM JACK ( AT & T ) CAT -6	575.00	10

**BEE-FIVE HOTEL & HOSPITALITY RANGE**

CODE	ITEM	MRP ₹ WHITE	PKG.
451901W	32A DP MAIN SWITCH KEYTAG	500.00	10
451902W	TAGKEY TAG RING ONLY	100.00	20
451903W	DND / MAKE MY ROOM IND UNIT OUTSIDE ROOM 2M (PRICES ARE WITHOUT FRAME)	600.00	1
451904W	DND / MAKE MY ROOM WITH 2 SWITCH UNIT INSIDE ROOM WITH DOOR BELL CUT OFF WIRING 3M (PRICES ARE WITHOUT FRAME)	700.00	1

**LED FOOT LIGHT / LED NIGHT LAMP**

CODE	ITEM	MRP ₹ WHITE	PKG.
452001W	STEP MARKER LIGHT 2M (WHITE)	350.00	10
452011W	STEP MARKER LIGHT 2M (W/ WHITE)	350.00	10
452002W	STEP MARKER LIGHT 3M (WHITE)	400.00	10
452012W	STEP MARKER LIGHT 3M (W/ WHITE)	400.00	10
452003W	NIGHT LAMP 2M (COOL WHITE)	300.00	10

**MCB'S & MOTOR STARTER**

CODE	ITEM	MRP ₹ WHITE	PKG.
452201W	SINGLE POLE MCB 6A.	250.00	12
452211W	SINGLE POLE MCB 10A.	250.00	12
452221W	SINGLE POLE MCB 16A.	250.00	12
452231W	SINGLE POLE MCB 20A.	250.00	12
452241W	SINGLE POLE MCB 25A.	250.00	12
452251W	SINGLE POLE MCB 32A.	250.00	12
452202W	DOUBLE POLE MCB 6A.	475.00	06
452212W	DOUBLE POLE MCB 10A.	475.00	06
452222W	DOUBLE POLE MCB 16A.	475.00	06
452232W	DOUBLE POLE MCB 20A.	475.00	06
452242W	DOUBLE POLE MCB 25A.	475.00	06
452252W	DOUBLE POLE MCB 32A.	475.00	06
452101W	SINGLE PHASE MOTOR STARTER 25A.	500.00	10

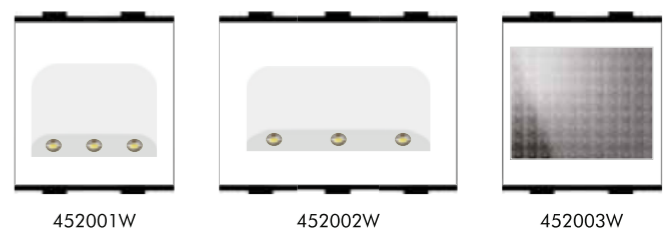
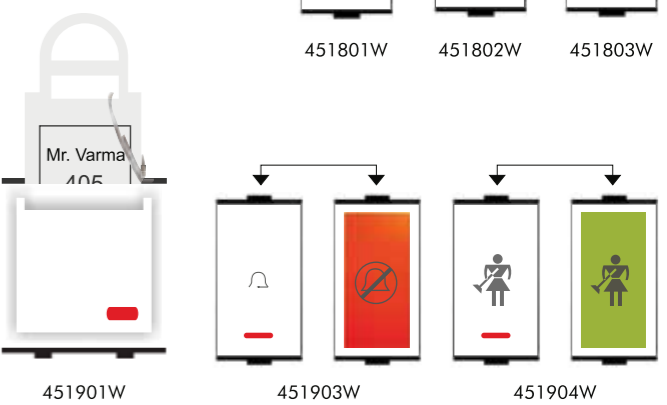
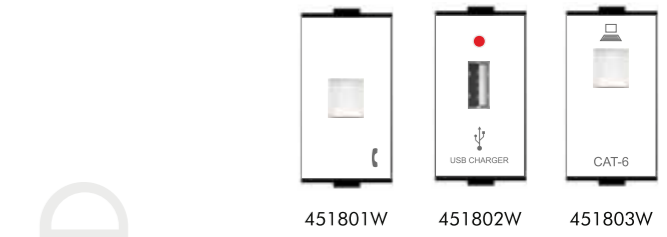
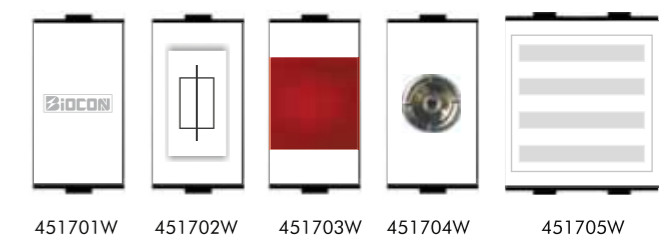
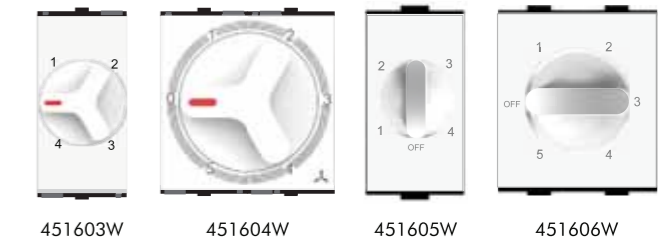

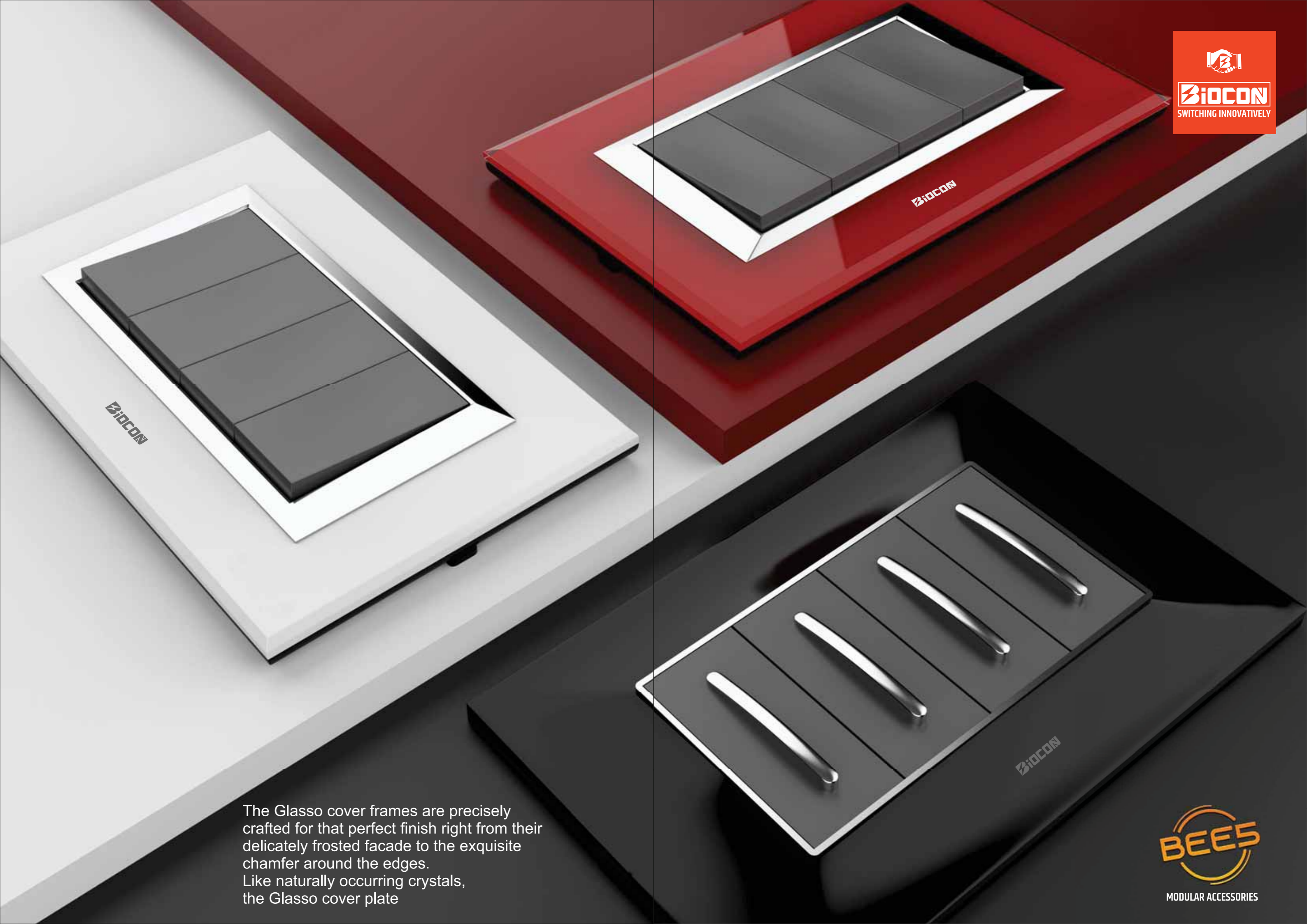

The Glasso cover frames are precisely crafted for that perfect finish right from their delicately frosted facade to the exquisite chamfer around the edges. Like naturally occurring crystals, the Glasso cover plate





MODULAR ACCESSORIES

GLASSO PLATES

MODULES ⇨	2M	3M	4M	6M	8M Sq.	8M Hz.	12M	18M
PLATES	CODE	CODE	CODE	CODE	CODE	CODE	CODE	CODE
⇩	MRP ₹	MRP ₹	MRP ₹	MRP ₹	MRP ₹	MRP ₹	MRP ₹	MRP ₹
COPPER GLASS	452601CG 650.00	452602CG 750.00	452603CG 875.00	452604CG 1300.00	452605CG 1600.00	452606CG 1600.00	452607CG 1800.00	452608CG 2500.00
BLACK GLASS	452601BG 650.00	452602BG 750.00	452603BG 875.00	452604BG 1300.00	452605BG 1600.00	452606BG 1600.00	452607BG 1800.00	452608BG 2500.00
RED GLASS	452601RG 650.00	452602RG 750.00	452603RG 875.00	452604RG 1300.00	452605RG 1600.00	452606RG 1600.00	452607RG 1800.00	452608RG 2500.00
WHITE GLASS	452601WG 650.00	452602WG 750.00	452603WG 875.00	452604WG 1300.00	452605WG 1600.00	452606WG 1600.00	452607WG 1800.00	452608WG 2500.00
METALLIC GLASS	452601MG 720.00	452602MG 890.00	452603MG 1005.00	452604MG 1550.00	452605MG 1895.00	452606MG 1895.00	452607MG 2185.00	452608MG 2875.00
PKG.	10	10	10	5	5	5	5	5
APPROX SIZE IN MM	106X93	130X93	163X93	228X93	270X93	165X165	228X165	228X230

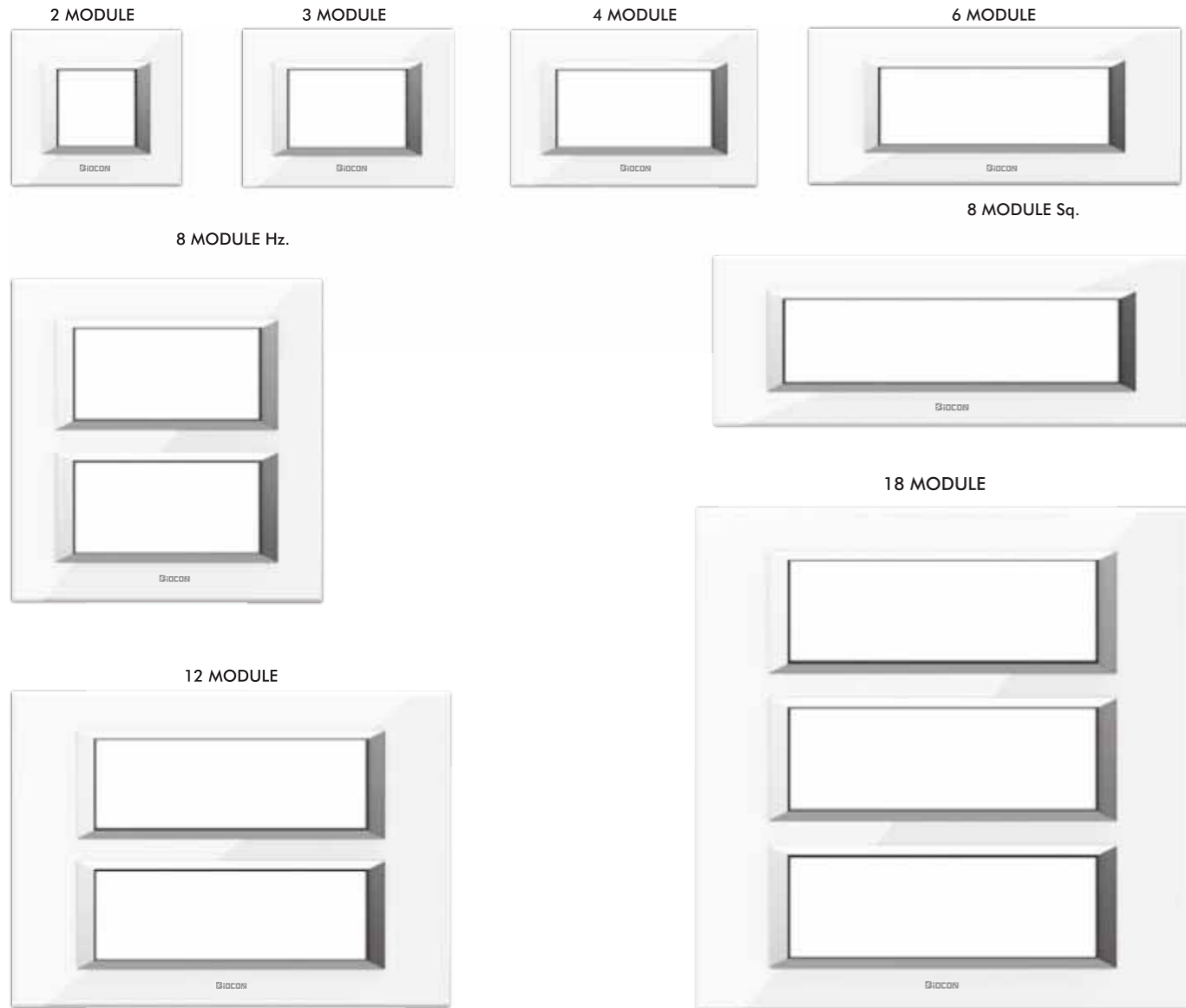

GLASSO PLATE BASE MOUNTING FRAME

MODULES ⇨	2M	3M	4M	6M	8M SQ.	8M HZ.	12M	18M
SUPPORT FRAME	CODE	CODE	CODE	CODE	CODE	CODE	CODE	CODE
	MRP ₹	MRP ₹	MRP ₹	MRP ₹	MRP ₹	MRP ₹	MRP ₹	MRP ₹
CODE	452601 50.00	452602 60.00	452603 70.00	452604 80.00	452605 95.00	452606 95.00	452607 120.00	452608 200.00
PKG.	25	25	25	20	20	20	20	10

SUPPORT FRAME FOR GLASSO PLATES

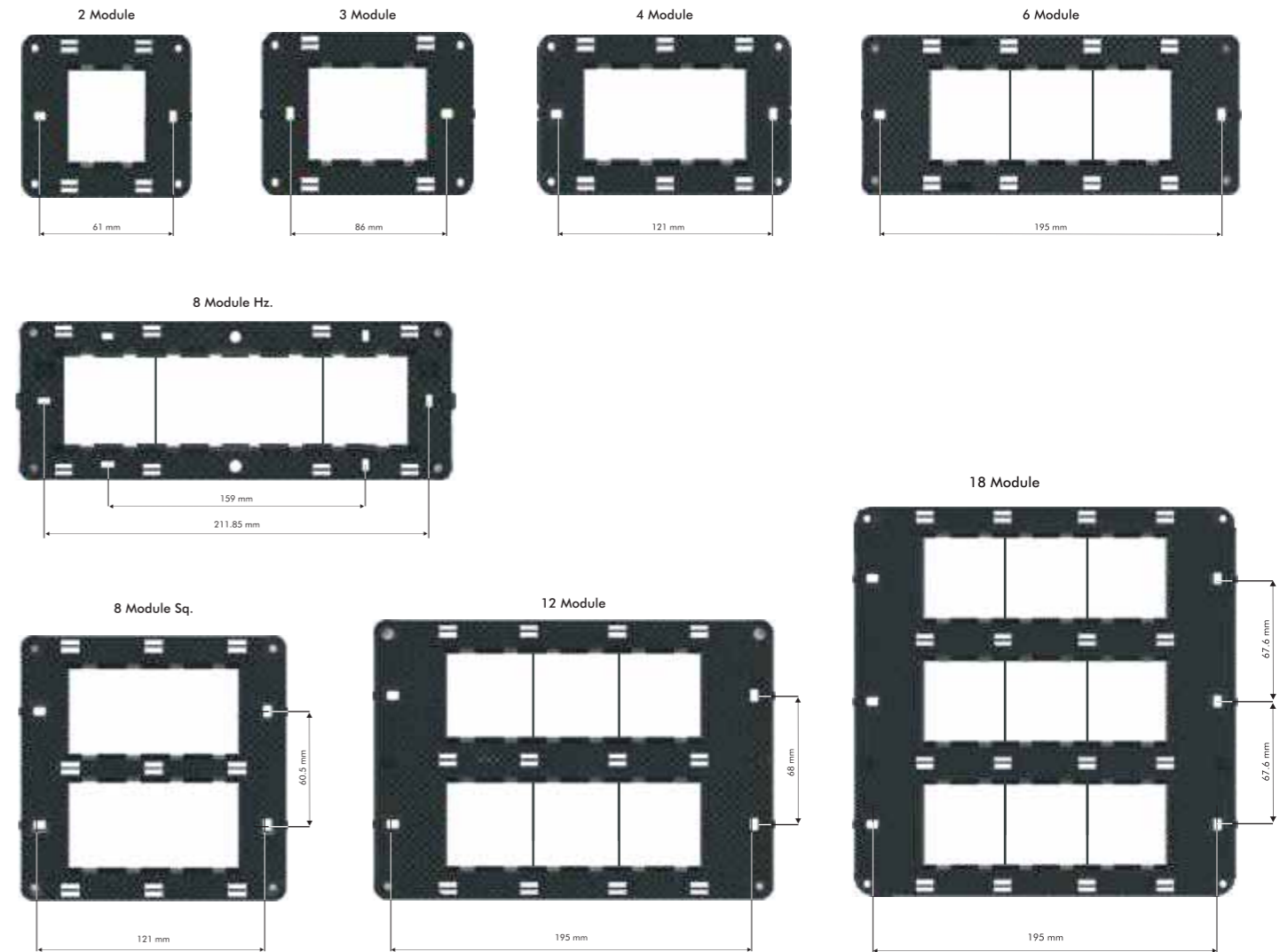

“BLING PLATE” HORIZONTAL & VERTICAL POSSIBILITIES



MODULAR ACCESSORIES



BLING PLATES (with Support Frame)

MODULES →	1M	2M	3M	4M	6M	8M Sq.	8M Hz.	12M	16M	18M
PLATES	CODE	CODE	CODE	CODE	CODE	CODE	CODE	CODE	CODE	CODE
↓	MRP ₹	MRP ₹	MRP ₹	MRP ₹	MRP ₹	MRP ₹	MRP ₹	MRP ₹	MRP ₹	MRP ₹
WHITE SILVERLINE	452301W 85.00	452302W 85.00	452303W 105.00	452304W 125.00	452305W 180.00	452306W 220.00	452307W 220.00	452308W 270.00	452309W 325.00	452310W 400.00
METT BLACK SILVERLINE	452301MB 120.00	452302MB 120.00	452303MB 165.00	452304MB 195.00	452305MB 280.00	452306MB 340.00	452307MB 340.00	452308MB 425.00	452309MB 475.00	452310MB 525.00
METALLIC GRAY SILVERLINE	452301GS 120.00	452302GS 120.00	452303GS 165.00	452304GS 195.00	452305GS 280.00	452306GS 340.00	452307GS 340.00	452308GS 425.00	452309GS 475.00	452310GS 525.00
METALLIC GRAY COPPER LINE	452401CG 120.00	452402CG 120.00	452403CG 165.00	452404CG 195.00	452405CG 280.00	452406CG 340.00	452407CG 340.00	452408CG 425.00	452409CG 475.00	452410CG 525.00
GOLD MINE	452401GM 120.00	452402GM 120.00	452403GM 165.00	452404GM 195.00	452405GM 280.00	452406GM 340.00	452407GM 340.00	452408GM 425.00	452409GM 475.00	452410GM 525.00
DIGI. SILVER	452401DS 120.00	452402DS 120.00	452403DS 165.00	452404DS 195.00	452405DS 280.00	452406DS 340.00	452407DS 340.00	452408DS 425.00	452409DS 475.00	452410DS 525.00
ITALIAN WOOD	452501IW 165.00	452502IW 165.00	452503IW 225.00	452504IW 260.00	452505IW 375.00	452506IW 475.00	452507IW 475.00	452508IW 550.00	452509IW 610.00	452510IW 700.00
MULBERRY TEAK	452501MT 165.00	452502MT 165.00	452503MT 225.00	452504MT 260.00	452505MT 375.00	452506MT 475.00	452507MT 475.00	452508MT 550.00	452509MT 610.00	452510MT 700.00
PKG.	10	10	10	10	10	10	10	10	5	5
APPROX SIZE IN MM	95X90	95X90	120X90	163X90	228X90	165X165	270X90	228X165	270X165	228X230

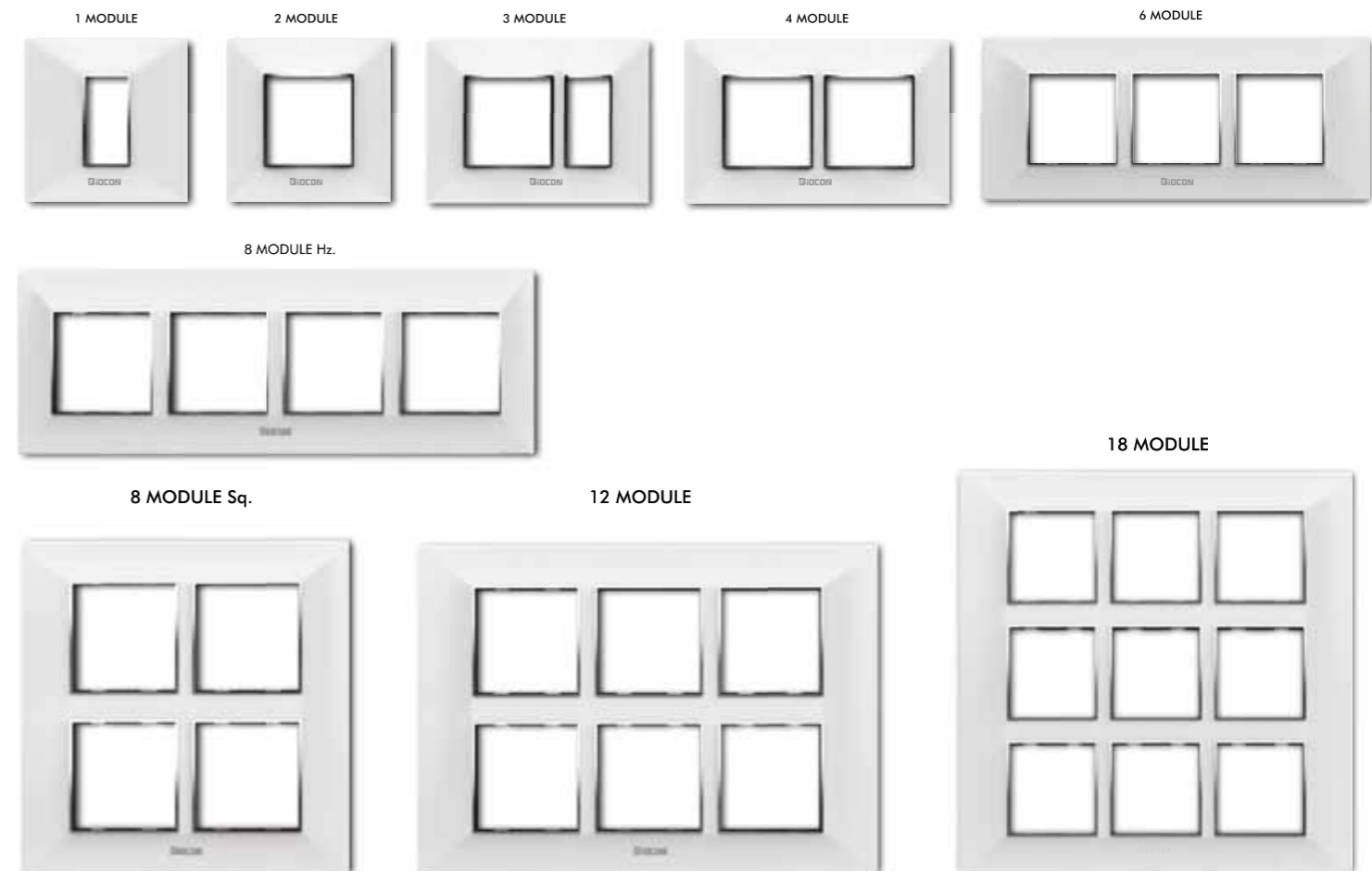



# Plates that suit every interior decor

Classy and minimalistic, the BEE-5 range of modular inserts project a sleek, elegant presence on your walls. **BIOCON** introduces a variety of high quality lifestyle products that will change the way you look at modular switches and functions.



**B-FIT WOOD PLATES** Suitable For Wooden & metal box

## B-FIT WOOD PLATES (with Support Frame) Suitable For Wooden & metal box

MODULES ⇨	1M	2M	3M	4M	6M	8M Hz.	8M Sq.	10M	12M Hz.	12M Sq.	16M	18M	20M
PLATES	CODE	CODE	CODE	CODE	CODE	CODE	CODE	CODE	CODE	CODE	CODE	CODE	CODE
↓	MRP ₹	MRP ₹	MRP ₹	MRP ₹	MRP ₹	MRP ₹	MRP ₹	MRP ₹	MRP ₹	MRP ₹	MRP ₹	MRP ₹	MRP ₹
WHITE	452701W 105.00	452702W 105.00	452703W 110.00	452704W 120.00	452705W 175.00	452706W 210.00	452714W 210.00	452707W 240.00	452708W 315.00	452709W 270.00	452710W 345.00	452711W 460.00	452712W 460.00
METALLIC GRAY	452701MG 150.00	452702MG 150.00	452703MG 155.00	452704MG 200.00	452705MG 255.00	452706MG 320.00	452714MG 300.00	452707MG 345.00	452708MG 460.00	452709MG 390.00	452710MG 490.00	452711MG 600.00	452712MG 600.00
BLACK	452701BW 175.00	452702BW 175.00	452703BW 190.00	452704BW 240.00	452705BW 310.00	452706BW 370.00	452714BW 320.00	452707BW 400.00	452708BW 520.00	452709BW 520.00	452710BW 600.00	452711BW 720.00	452712BW 720.00
PKG.	10	10	10	10	10	10	10	10	10	5	5	5	5

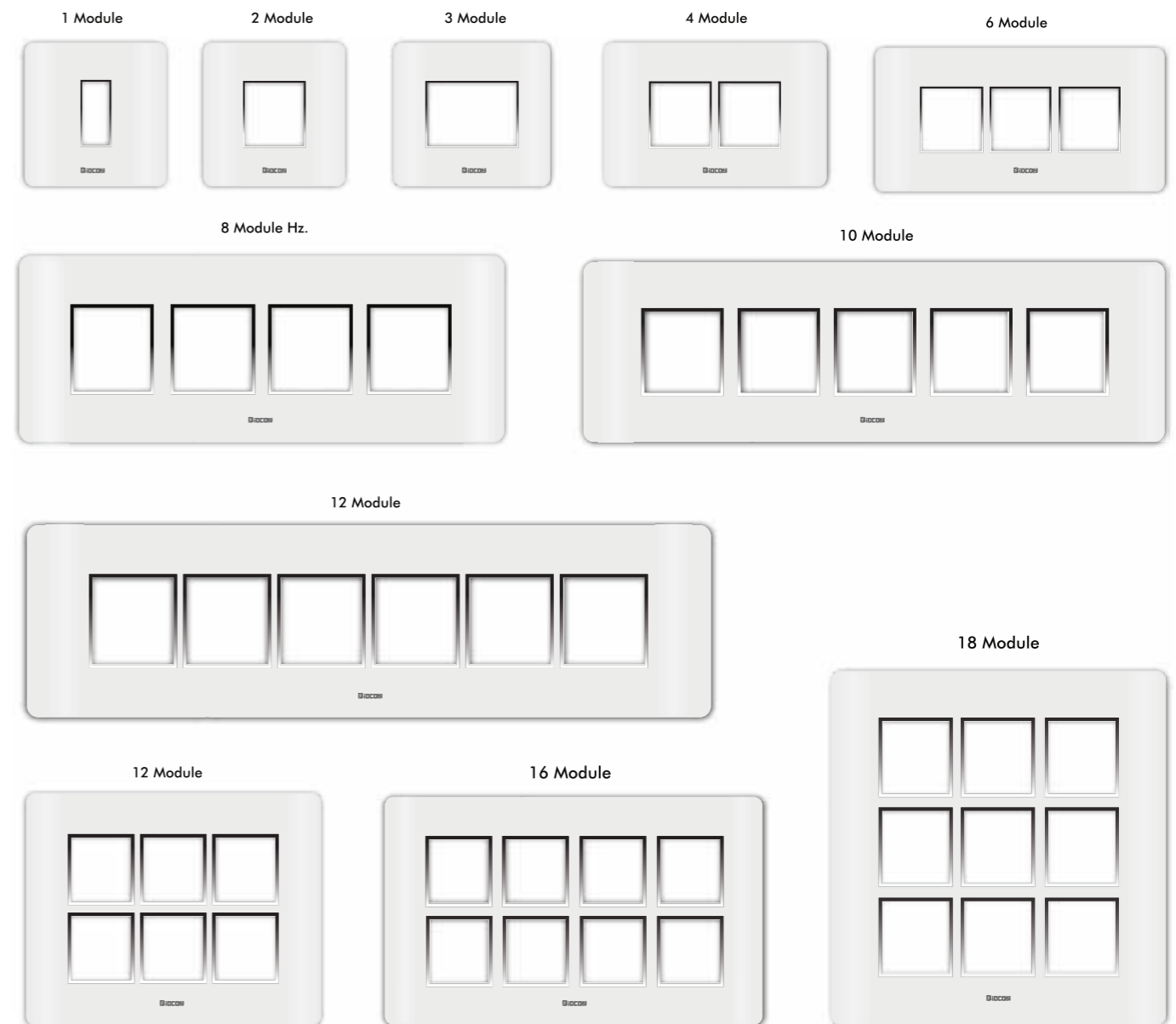

I am a believer

that

color

affects peoples moods



### colours of bling cover frame

#### GLOSSY



WHITE SILVERLINE



METT BLACK SILVERLINE

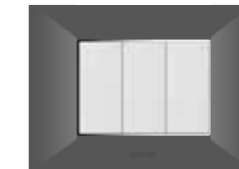

METALLIC GRAY SILVERLINE

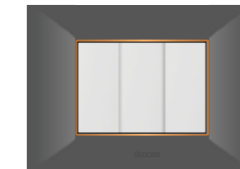

METALLIC GRAY COPPER LINE

#### METALLIC



GOLD MINE



DIGI. SILVER

#### WOOD



ITALIAN WOOD



MULBERRY TEAK

### colours of glasso cover frame



WHITE GLASS



BLACK GLASS



RED GLASS



METALLIC GLASS



COPPER GLASS

### colours of B-FIT cover frame



WHITE



METALLIC GRAY



BLACK OAK WOOD

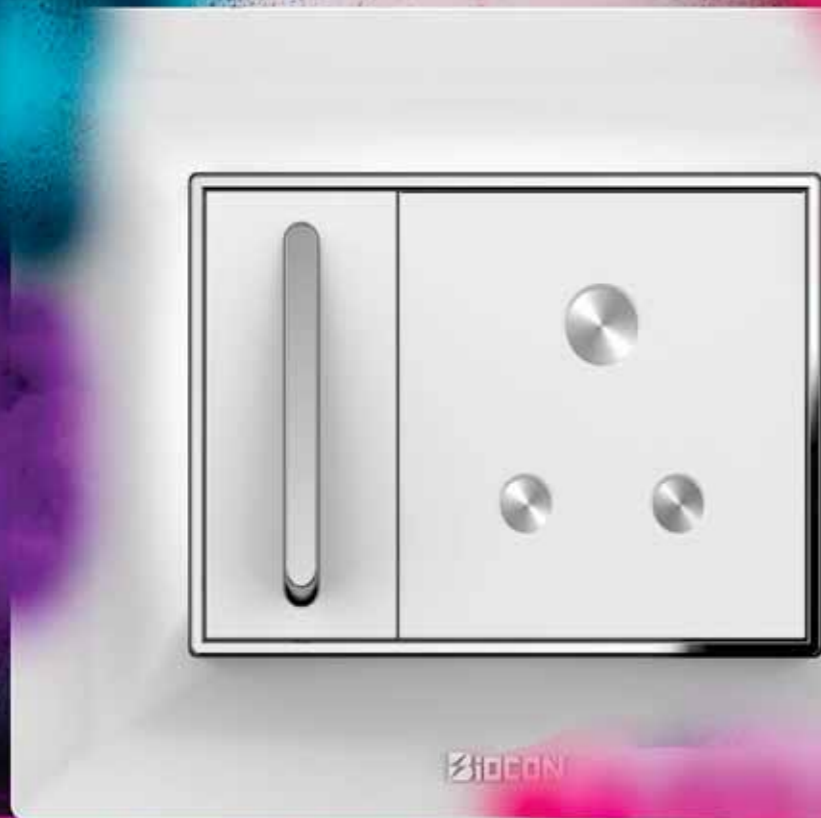

NOTE : the cover plate may differ in their shades as the reflect a natural look



The ROSSA range of modular switches and systems breaks the mold with its classy, minimalistic, uniquely flat, and slim appearance. An example of meticulous craftsmanship, careful detailing, and unmatched excellence, the ROSSA range makes other ordinary switch ranges appear unwieldy and extravagant. Absolutely light and modern, the ROSSA range marks a new beginning in the world of standard fittings. Slim, stylish, minimal – the ROSSA Accessories shout quality, elegance, and finesse through every inch of their presence.



# ROSSA MODULAR SYSTEM

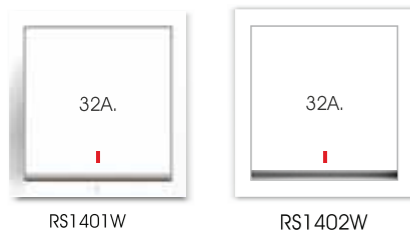
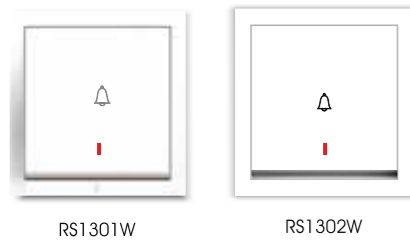
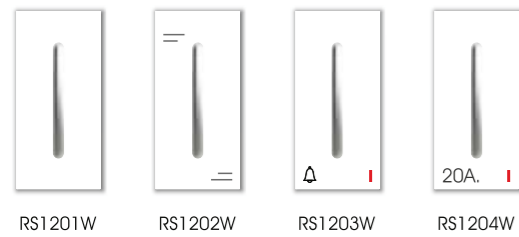
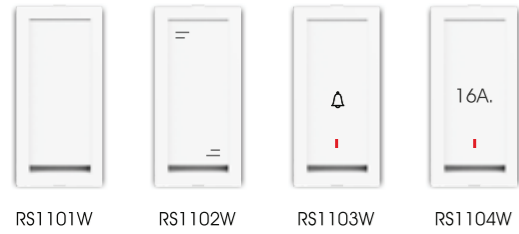
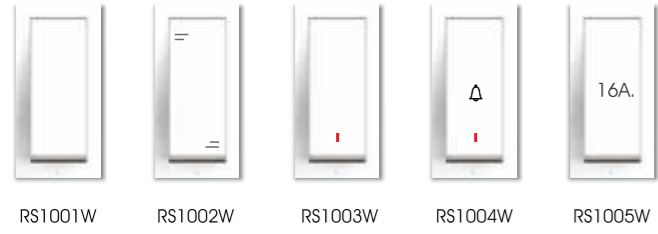

CODE ITEM MRP ₹ PKG.

6A./ 16A. ROSSA MODULAR SWITCH

RS1001W	6A 1 WAY SWITCH	45.00	20
RS1002W	6A 2 WAY SWITCH	63.00	20
RS1003W	6A 1 WAY SWITCH with Indicator	65.00	20
RS1004W	6A BELL PUSH with Indicator	77.00	20
RS1005W	16A 1 WAY SWITCH with Indicator	90.00	20

6A./ 16A. FLATO MODULAR SWITCH

RS1101W	6A 1 WAY SWITCH	46.00	20
RS1102W	6A 2 WAY SWITCH	66.00	20
RS1103W	6A BELL PUSH with Indicator	80.00	20
RS1104W	16A 1 WAY SWITCH with Indicator	95.00	20

6A./ 20A. RENZO MODULAR SWITCH

RS1111W	6A 1 WAY SWITCH	48.00	20
RS1112W	6A 2 WAY SWITCH	70.00	20
RS1113W	6A BELL PUSH with Indicator	85.00	20
RS1114W	20A 1 WAY SWITCH with Indicator	105.00	20

6A./ 20A. B-SLIQ MODULAR SWITCH

RS1201W	6A 1 WAY SWITCH	45.00	20
RS1202W	6A 2 WAY SWITCH	70.00	20
RS1203W	6A BELL PUSH with Indicator	85.00	20
RS1204W	20A 1 WAY SWITCH with Indicator	100.00	20

6A. JUMBO MODULAR SWITCH 2M

RS1301W	6A ROSSA BELL PUSH with Indicator	95.00	10
RS1302W	6A FLATO BELL PUSH with Indicator	110.00	10

32A. JUMBO MODULAR DP SWITCH 2M

RS1401W	32A ROSSA DP SWITCH with Indicator	235.00	10
RS1402W	32A FLATO DP SWITCH with Indicator	250.00	10

CODE ITEM MRP ₹ PKG.

6A. SOCKET OUTLET 2M

RS1501W	6A 3 PIN SOCKET	50.00	10
RS1502W	6A 3 PIN SOCKET with safety shutter	65.00	10
RS1601W	6A / 16A 2 IN 1 SOCKET with porcelain base	110.00	10
RS1602W	6A / 16A 2 IN 1 SOCKET with safety shutter	125.00	10

EME FAN REGULATOR & DIMMERS

RS1701W	JOY MINI DIMMER 1M	200.00	10
RS1702W	JOY MEDIUM DIMMER 2M	270.00	10
RS1703W	ROSSA EME 4 STEP FAN REGU.	295.00	10
RS1704W	ROSSA EME 5 STEP FAN REG.	350.00	10

ANCILLARIES

RS1801W	BLANK PLATE 1M	16.00	50
RS1802W	KITKAT FUSE 10A & 16A 1M	125.00	10
RS1803W	NEON INDICATOR 1M	70.00	10
RS1804W	MINI TV SOCKET 1M	70.00	10
RS1805W	ELECTRIC BUZZER 2M	245.00	10
RS1806W	2A BED SWITCH	45.00	30

IT PRODUCTS / HOTEL & HOSPITALITY RANGE

RS1901W	RJ 11 TEL JACK SINGLE	100.00	10
RS1902W	USB CHARGER 1M with Indicator	600.00	10
RS1903W	TYPE "C" & USB CHARGER 1M with Indicator	700.00	10
RS1904W	RJ45 JACK ( AT & T ) CAT -6	550.00	10
RS2001W	32A DP MAIN SWITCH WITH KEY RING	400.00	10
RS2002W	TAGKEY RING TAG ONLY	75.00	20

LED FOOT LIGHT / LED NIGHT LAMP

RS2101W	MINI FOOT LIGHT 2M (WHITE)	260.00	10
RS2111W	MINI FOOT LIGHT 2M (W/ WHITE)	260.00	10
RS2102W	MINI FOOT LIGHT 3M (WHITE)	280.00	10
RS2112W	MINI FOOT LIGHT 3M (W/ WHITE)	280.00	10
RS2103W	NIGHT LAMP 2M (COOL WHITE)	250.00	10
RS2104W	4M FOOT LIGHT (WHITE)	520.00	5
RS2114W	4M FOOT LIGHT (W/ WHITE)	520.00	5

MCB'S & MOTOR STARTER

RS2301W	SINGLE POLE MCB 6A.	175.00	12
RS2311W	SINGLE POLE MCB 10A.	175.00	12
RS2321W	SINGLE POLE MCB 16A.	175.00	12
RS2331W	SINGLE POLE MCB 20A.	175.00	12
RS2341W	SINGLE POLE MCB 25A.	175.00	12
RS2351W	SINGLE POLE MCB 32A.	175.00	12
RS2302W	DOUBLE POLE MCB 6A.	375.00	06
RS2312W	DOUBLE POLE MCB 10A.	375.00	06
RS2322W	DOUBLE POLE MCB 16A.	375.00	06
RS2332W	DOUBLE POLE MCB 20A.	375.00	06
RS2342W	DOUBLE POLE MCB 25A.	375.00	06
RS2352W	DOUBLE POLE MCB 32A.	375.00	06
RS2201W	MOTOR STARTER 25A. S.P.	425.00	10

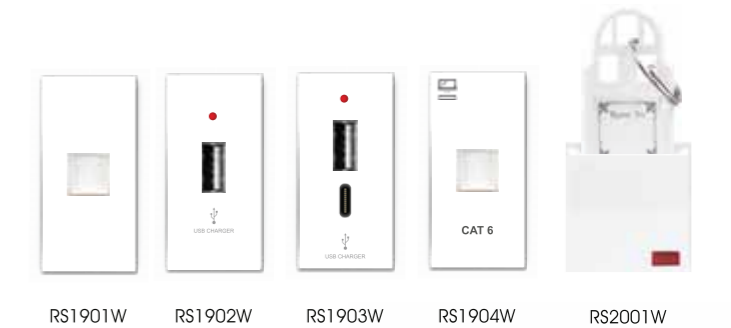
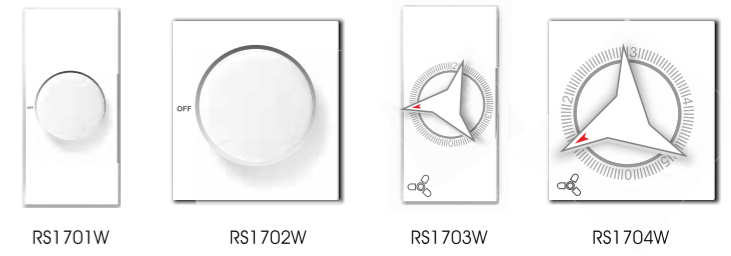
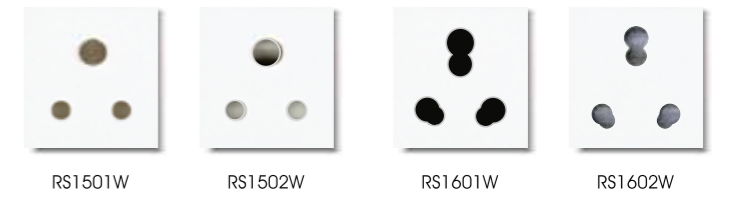

**B-RADIUS PLATES (with Support Frame)**

MODULES ⇨	1M	2M	3M	4M	6M	8M Sq.	8M Hz.	12M	16M	18M
PLATES	CODE	CODE	CODE	CODE	CODE	CODE	CODE	CODE	CODE	CODE
↓	MRP ₹	MRP ₹	MRP ₹	MRP ₹	MRP ₹	MRP ₹	MRP ₹	MRP ₹	MRP ₹	MRP ₹
WHITE	RS2401W 65.00	RS2402W 65.00	RS2403W 85.00	RS2404W 95.00	RS2405W 145.00	RS2406W 195.00	RS2407W 195.00	RS2408W 235.00	RS2409W 290.00	RS2410W 310.00
METALLIC GRAY	RS2401MG 110.00	RS2402MG 110.00	RS2403MG 135.00	RS2404MG 150.00	RS2405MG 215.00	RS2406MG 295.00	RS2407MG 295.00	RS2408MG 360.00	RS2409MG 440.00	RS2410MG 460.00
BLACK WOOD	RS2401BW 135.00	RS2402BW 135.00	RS2403BW 165.00	RS2404BW 195.00	RS2405BW 290.00	RS2406BW 380.00	RS2407BW 380.00	RS2408BW 440.00	RS2409BW 525.00	RS2410BW 575.00
PKG.	10	10	10	10	10	10	10	10	5	5
APPROX SIZE IN MM	106X90	106X90	118X90	146X90	228X93	270X93	165X165	228X165	270X165	228X230

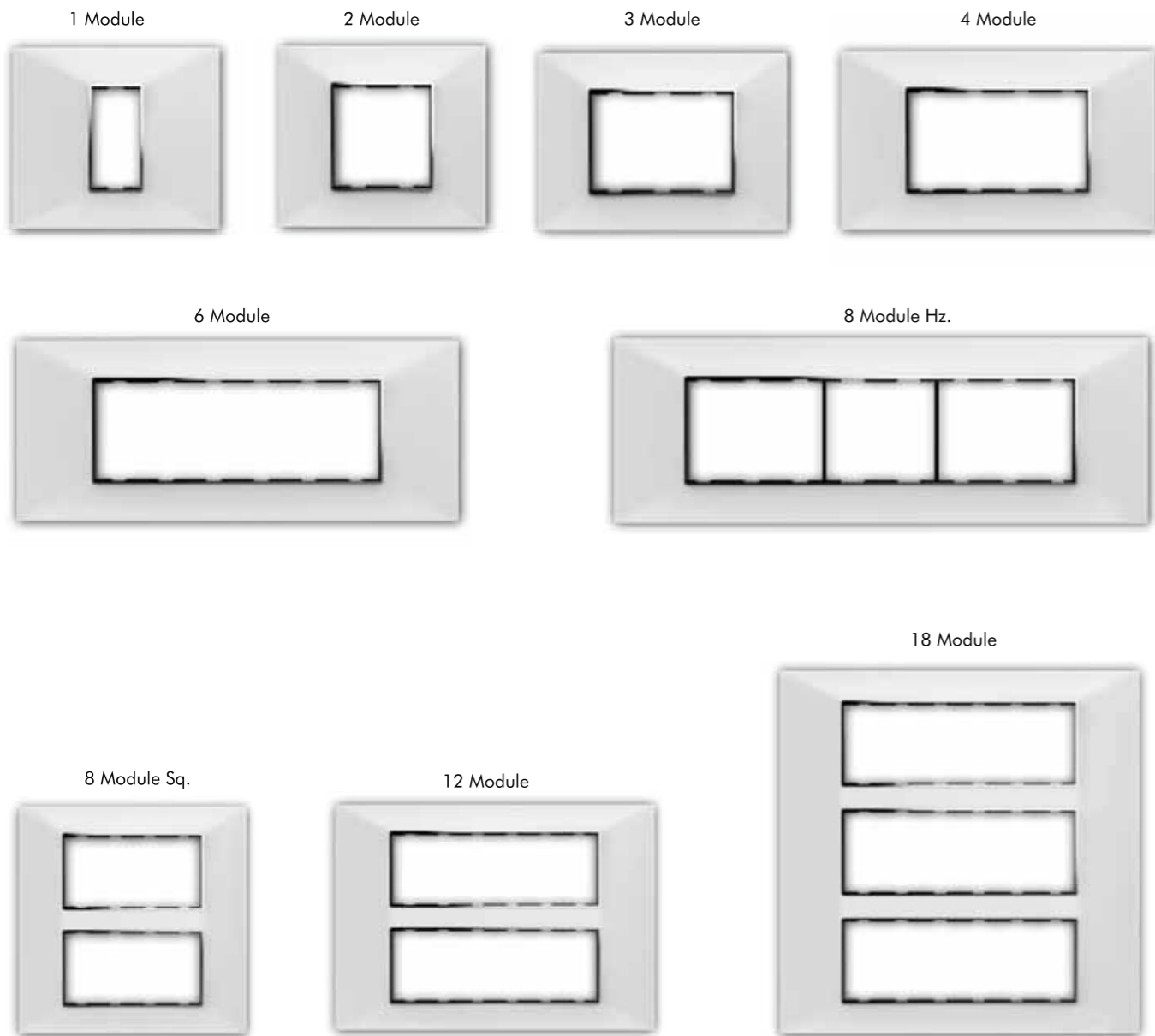

**B-WOOD PLATES (with Support Frame) Suitable For Wooden & metal box**

MODULES ⇨	1M	2M	3M	4M	6M	8M Hz.	8M Sq.	10M	12M Hz.	12M Sq.	16M	18M	20M
PLATES	CODE	CODE	CODE	CODE	CODE	CODE	CODE	CODE	CODE	CODE	CODE	CODE	CODE
↓	MRP ₹	MRP ₹	MRP ₹	MRP ₹	MRP ₹	MRP ₹	MRP ₹	MRP ₹	MRP ₹	MRP ₹	MRP ₹	MRP ₹	MRP ₹
WHITE	RS2501W 90.00	RS2502W 90.00	RS2503W 95.00	RS2504W 115.00	RS2505W 150.00	RS2506W 190.00	RS2513W 210.00	RS2507W 210.00	RS2508W 275.00	RS2509W 235.00	RS2510W 300.00	RS2511W 400.00	RS2512W 375.00
METALLIC GRAY	RS2501MG 130.00	RS2502MG 130.00	RS2503MG 135.00	RS2504MG 175.00	RS2505MG 220.00	RS2506MG 280.00	RS2513MG 300.00	RS2507MG 300.00	RS2508MG 400.00	RS2509MG 340.00	RS2510MG 425.00	RS2511MG 525.00	RS2512MG 500.00
BLACK OAK WOOD	RS2501BW 150.00	RS2502BW 150.00	RS2503BW 165.00	RS2504BW 210.00	RS2505BW 270.00	RS2506BW 320.00	RS2513BW 320.00	RS2507BW 320.00	RS2508BW 450.00	RS2509BW 450.00	RS2510BW 525.00	RS2511BW 625.00	RS2512BW 560.00
PKG.	10	10	10	10	10	10	10	10	10	5	5	5	5



## colours of B-RADIUS cover frame

### GLOSSY



WHITE  
SILVERLINE

### METALLIC



METALLIC GRAY  
SILVERLINE

### WOOD

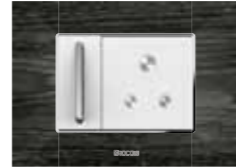

BLACK WOOD

## colours of B-WOOD cover frame



WHITE



METALLIC GRAY



BLACK OAK WOOD



colours of plate



B-WOOD PLATE



Heavy Duty  
Switches & Accessories



RS3501W

RS3507W



RS3502W

RS3503W



RS3504W



RS3505W

RS3506W

CODE	DESCRIPTION	MRP ₹	PKG.
<b>SURFACE RANGE - SS COMBINED &amp; DP SWITCH</b>			
RS3501W	6AMP 2 IN 1 SS COMBINED WITH JUNCTION BOX	130.00	10
RS3507W	6AMP DOUBLE SS COMBINED WITH JUNCTION BOX	240.00	5
RS3502W	16AMP 3 IN 1 SS COMBINED WITH JUNCTION BOX	205.00	5
RS3503W	16AMP 5 IN 1 SS COMBINED WITH JUNCTION BOX	305.00	5
RS3504W	16AMP 3 IN 1 DOUBLE SS COMBINED 2+2 WITH JUNCTION BOX WITH FUSE AND WITH IND.	420.00	5
RS3505W	32A SURFACE MINI DP SWITCH	200.00	10
RS3506W	32A HEAVY DUTY SURFACE DP SWITCH WITH INDICATOR	225.00	10



### SILVEREX GANG BOX WITH MODULAR PLATE

MODULES →	1M	2M	3M	4M	6M	8M Hz.	8MVRT.	9M	12M	16M	18M
SURFACE GANG BOXES	CODE	CODE	CODE	CODE	CODE	CODE	CODE	CODE	CODE	CODE	CODE
↓	MRP₹	MRP₹	MRP₹	MRP₹	MRP₹	MRP₹	MRP₹	MRP₹	MRP₹	MRP₹	MRP₹
WHITE	RS2601W	RS2602W	RS2603W	RS2604W	RS2605W	RS2606W	RS2607W	RS2608W	RS2609W	RS2610W	RS2611W
SILVER LINE	50.00	60.00	75.00	85.00	105.00	120.00	120.00	130.00	160.00	200.00	230.00
PKG.	20	20	10	10	10	10	10	10	5	5	5
APPROX SIZE IN MM	60X85X50	90X85X50	115X85X50	141X85X50	218X85X50	251X85X50	150X145X60	180X145X60	215X156X60	215X156X60	222X215X60
LengthxWidthxDepth											

## SILVEREX GANG BOX

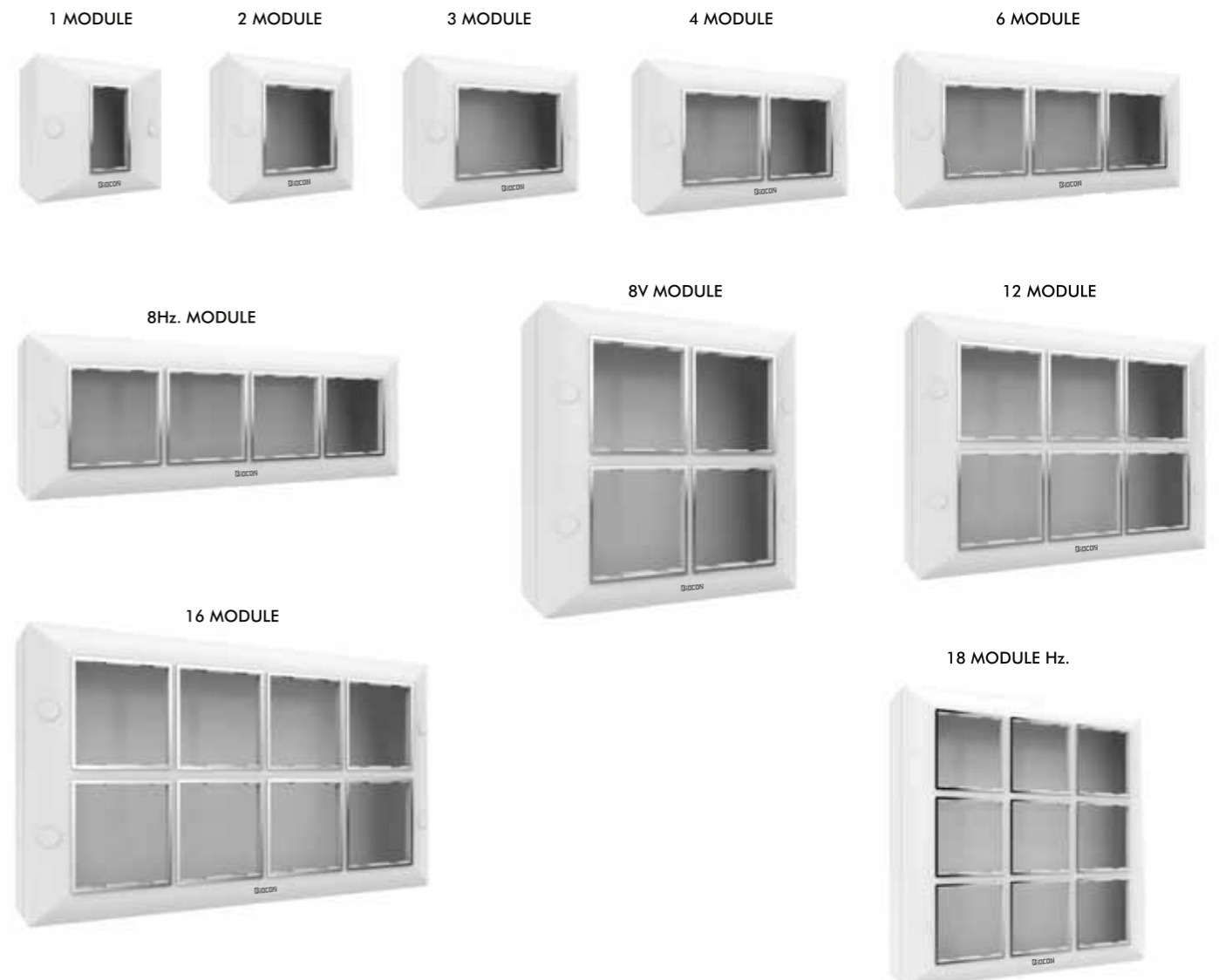

**Salient Features :**  
\* Made from special Grade Virgin ABS.



SURFACE UNBREAKABLE BOX									
MODULES ⇨	1 & 2M	3M	4M	6M	8M Sq.	8M Hz.	12M	16M	18M
CODE ⇨	RS2701W	RS2702W	RS2703W	RS2704W	RS2705W	RS2706W	RS2707W	RS2708W	RS2709W
	MRP ₹	MRP ₹	MRP ₹	MRP ₹	MRP ₹	MRP ₹	MRP ₹	MRP ₹	MRP ₹
WHITE	65.00	75.00	85.00	105.00	130.00	130.00	175.00	200.00	200.00
PKG.	20	10	10	10	10	10	05	05	05
APPROX SIZE IN MM	78X78X50	87X115X50	87X145X50	87X220X50	155X145X50	87X250X50	155X215X50	155X240X50	220X222X50

CANCELED G.I. SHEET METAL BOX									
MODULES ⇨	1 & 2M	3M	4M	6M	8M Sq.	8M Hz.	12M	16M	18M
CODE ⇨	RS2801	RS2802	RS2803	RS2804	RS2805	RS2806	RS2807	RS2808	RS2809
	MRP ₹	MRP ₹	MRP ₹	MRP ₹	MRP ₹	MRP ₹	MRP ₹	MRP ₹	MRP ₹
G.I. BOX	65.00	80.00	95.00	125.00	140.00	140.00	200.00	265.00	300.00
PKG.	60	40	30	20	20	20	10	10	10
APPROX SIZE IN MM	78X78X45	78X100X45	78X140X45	78X20X45	135X120X50	78X230X50	135X205X50	135X220X50	05X215X50

# BOXIT SURFACE BOX

## FOR MODULAR SERIES

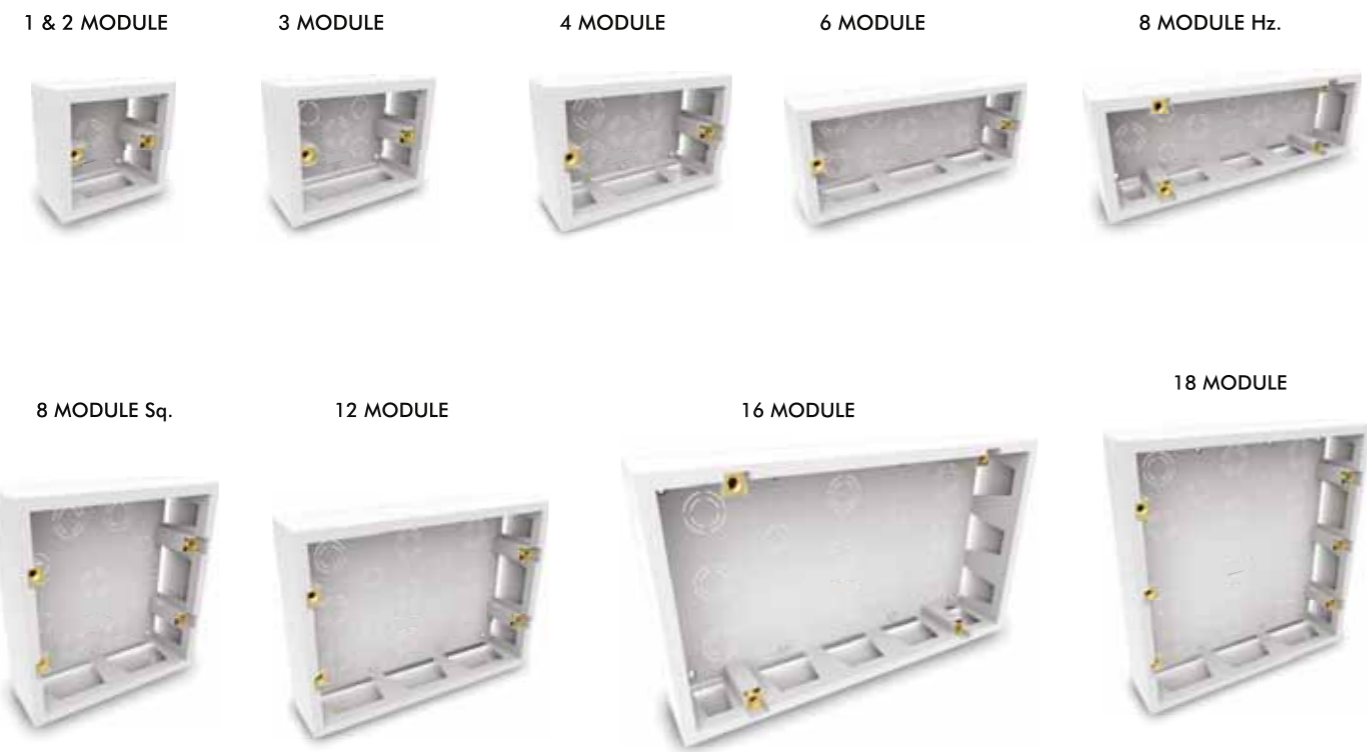

# CONCEALED METAL BOXES

## FOR MODULAR SERIES

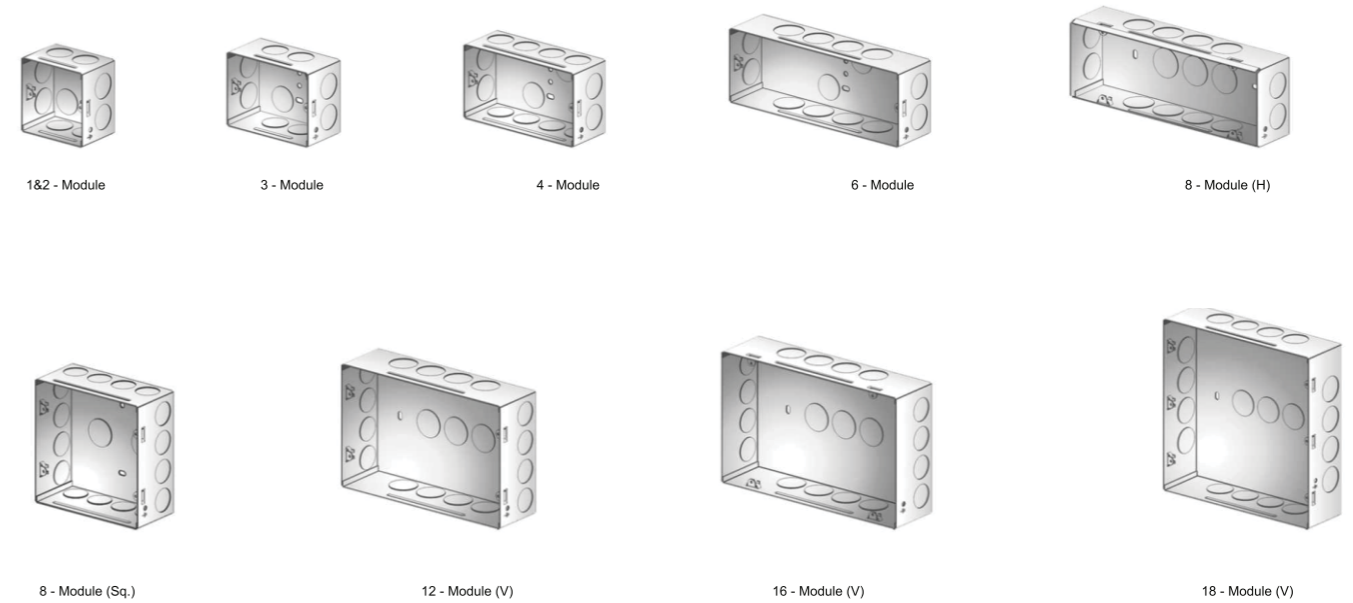

Silent Features : • 19 SWG GI Boxes,  
 • High Durability • Corrosion Resistant • With Earthing Terminal

# ROSSA

## MODULAR SYSTEM



CODE	DESCRIPTION	MRP ₹	PKG.
<b>CUBE HOLDERS &amp; PILOT CEILING ROSE</b>			
RS2901W	CUBE ANGLE HOLDER	46.00	20
RS2902W	CUBE BATTEN HOLDER	46.00	20
RS2907W	PILOT CEILING ROSE - PCR	43.00	20
<b>SQUARE HOLDERS &amp; CEILING ROSE</b>			
RS2903W	SQUARE ANGLE HOLDER 4.5 X 4.5	90.00	10
RS2904W	SQUARE BATTEN HOLDER 5 X 5	90.00	10
RS2909W	SQUARE CEILING ROSE 4.5 X 4.5	80.00	20
<b>PYRO HOLDERS &amp; JUMBO CEILING ROSE</b>			
RS2905W	PYRO ANGLE HOLDER (UNBREAKABLE)	40.00	20
RS2906W	PYRO BATTEN HOLDER (UNBREAKABLE)	40.00	20
RS2908W	JUMBO CEILING ROSE - JCR	50.00	20
<b>PENDANT HOLDERS &amp; ADAPTOR</b>			
RS2910W	MULTI PENDANT ADAPTOR	40.00	20
RS2911W	SKIRT PENDANT HOLDERS	38.00	20
RS2912W	PENDANT HOLDER BLACK	35.00	30
RS2915W	ADAPTOR	30.00	30
<b>FAN PLATES</b>			
RS2916W	FAN PLATE 4 INCH	20.00	100
RS2917W	FAN PLATE 7 INCH	36.00	50
<b>PLUG TOPS</b>			
RS3001W	DOME 6AMP 3 PIN TOP (UREA) HEAVY	100.00	20
RS3002W	DOME 16AMP 3 PIN TOP (UREA) HEAVY	135.00	10
RS3003W	ZOOM 6AMP 3 PIN TOP	75.00	20
RS3004W	ZOOM 16AMP 3 PIN TOP	105.00	10
RS3005W	B-STAR 6AMP 3 PIN TOP	80.00	20
RS3006W	B-STAR 16AMP 3 PIN TOP	105.00	10
<b>2 PIN PLUG TOPS</b>			
RS3007W	TINY 6AMP 2 PIN PLUG (HEAVY)	32.00	30
RS3008W	TINY 2 PIN MALE FEMALE (HEAVY)	60.00	30



CODE	DESCRIPTION	MRP ₹	PKG.
<b>UNIVERSAL TRAVEL ADAPTORS</b>			
RS3101W	OLA 6AMP 3 PIN MULTI PLUG	200.00	10
RS3102W	ZYLO 6/16AMP CONVERSION PLUG	225.00	10
RS3103W	SPACE 3 PIN UNI. ADAPTOR	115.00	10
RS3104W	ZELA 6A 3PIN MULTI PLUG	115.00	10
<b>DING DONG BELLS</b>			
RS3201W	ZIG ZAG DING DONG BELL	250.00	10
RS3202W	B-SPOT DING DONG BELL	250.00	10
RS3203W	TORA TORA DING DONG BELL	210.00	10
<b>MUSICAL BELLS</b>			
RS3204W	PYRAMID MUSICAL BELL	475.00	5
RS3205W	JANNAT MUSICAL BELL (AZAAN / SALAM)	475.00	5
RS3206W	CROCUS REMOTE BELL	1750.00	5
RS3207W	ORCHID PARROT BELL	325.00	5
RS3208W	MANTRA BELL (GAYATRI MANTRA)	425.00	5
<b>FLEX BOX EXTENSION BOARD</b>			
RS3301W	B CORD EXTENSION BOX 2PIN (4 MTR)	425.00	5
RS3302W	B SQUARE EXTENSION BOX 2 PIN (7 MTR)	500.00	5
RS3303W	B SQUARE EXTENSION BOX 3 PIN (4 MTR)	475.00	5
RS3304W	"B CONNECT EXTENSION BOX 3 PIN (4 MTR) WITH HANDLE IND & INT. SOCKET	575.00	5
RS3306W	B PACK EXTENSION BOX 16A 3 PIN (5MTR)	1150.00	1
<b>POWER STRIP</b>			
RS3401W	B STRIP SPIKE GUARD 4+1 (1.5 MTR)	715.00	5
RS3402W	B STRIP SPIKE GUARD 4+1 (4 MTR)	850.00	5
RS3403W	B STRIP SPIKE GUARD 4+4 (4 MTR)	975.00	5
RS3404W	B POWER SPIKE GUARD 4+1 (1.5 MTR)	600.00	5
RS3405W	B POWER SPIKE GUARD 4+1 (4 MTR)	750.00	5
RS3406W	B HANG SPIKE GUARD 4+4 (1.5 MTR)	1000.00	5



# FR SELF Adhesive PVC Electrical Insulation TAPE



NOW AVAILABLE

India's Highest  
Selling TAPE



At **BIOCON**,  
we take pride in creating high  
quality PVC INSULATION TAPE.

AVAILABLE IN ALL LEADING STORE IN INDIA

# MCB's

MINIATURE  
CIRCUIT BREAKER  
(10kA)

Automatically breaks  
the circuit if the  
current reaches a  
predetermined value

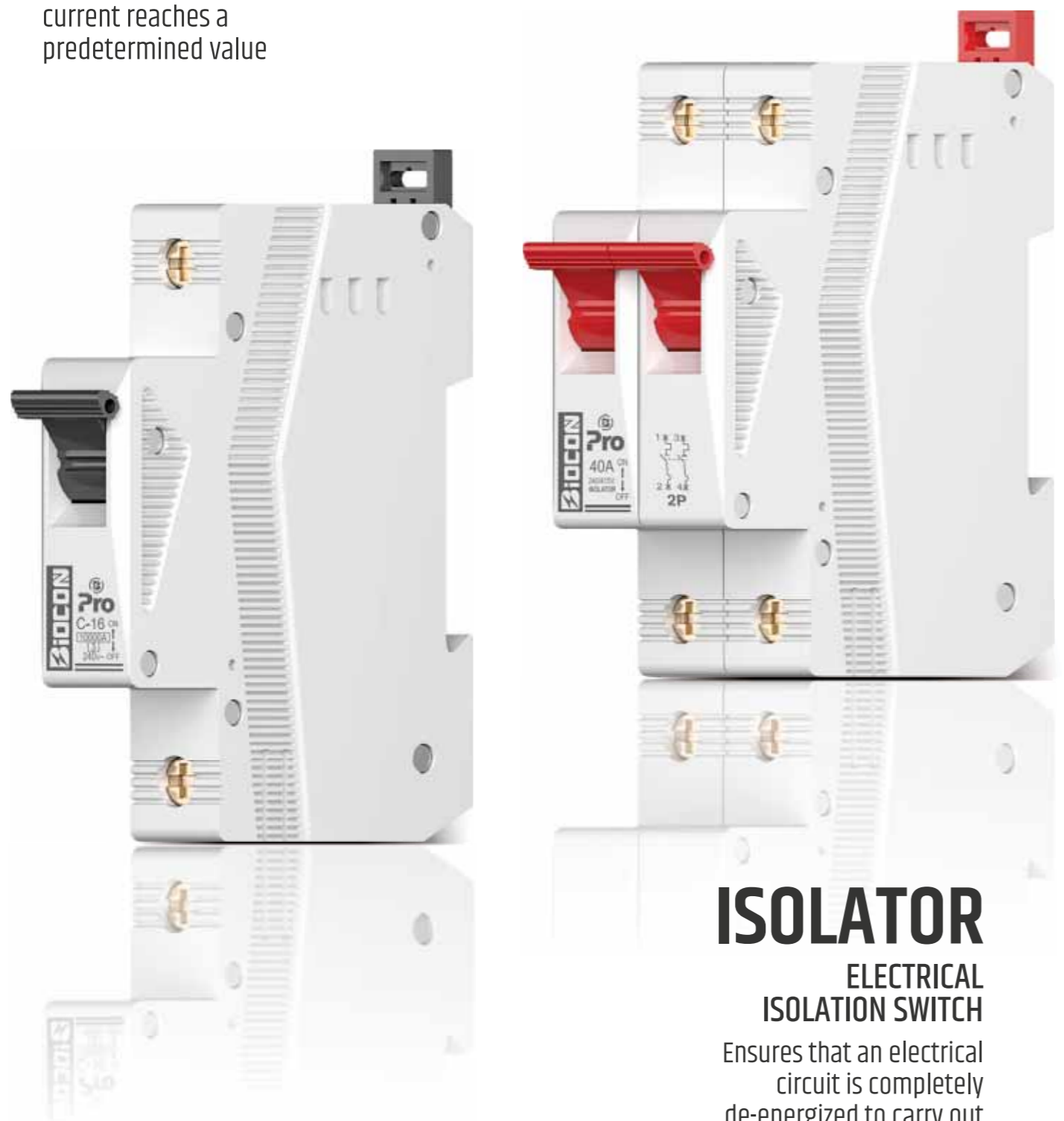

# THE POWER TO MAKE A DIFFERENCE

## ISOLATOR

ELECTRICAL  
ISOLATION SWITCH

Ensures that an electrical  
circuit is completely  
de-energized to carry out  
repairs and maintenance.



# Powering the future



# Brighter

LIGHT ON A  
DARKER  
NIGHT



BELLA COB DOWNLIGHT



DOME SURFACE CYLINDER



FOCUS ZOOM

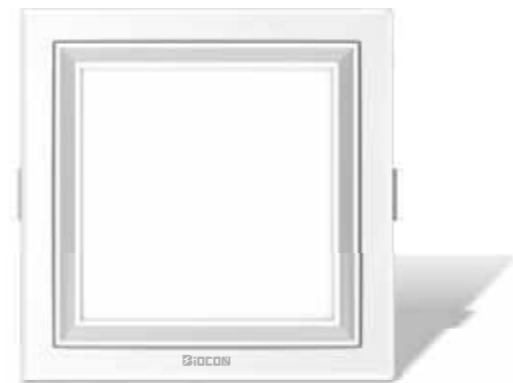

SLIMO LED



KIEV LED



B-ROTATE



FOCUS ZOOM



B-SLIQ - Round



ROADSTAR STREET LIGHT



RAINBOW



FLATO FLOOD LIGHT



TWISTER - Square

We bring to you the classic & luxury range of switches that adds a class to your dream home.

Different choice & range gives individual a new way to enhance the beauty of their home.

we care for safety of our customers.

The Range allows you to feel & cherish life to its fullest through a great design



TEAM

**BIOCON**

Connecting India.....

## BIOCON ELECTRIC [P] LIMITED

### DELHI

4/24/1, J.R. Complex No. 4,  
Mandoli Main Road,  
Trans Yamuna-110093 (INDIA)

### MAHARASHTRA

12, VK Industrial Complex,  
Bilal Pada, Vasai East-401208  
Suburban, Mumbai (INDIA)

### UTTAR PRADESH

B-13, Sector-63,  
Noida-201301 (UP)

### PUNJAB

BIOCON ELECTRIC PRIVATE LIMITED  
JALANDHAR

### JAMMU & KASHMIR

BIOCON ELECTRIC PRIVATE LIMITED  
SRINAGAR

### WEST BENGAL

BIOCON ELECTRIC PRIVATE LIMITED  
KOLKATA

### KARNATAKA

No. 234, 2nd Floor, Above Hotel  
Vijay Vihar, Garudachar Complex,  
Chickpet, Bangalore-560053 (INDIA)

### TAMIL NADU

Door No. 25, New No. 47, Mint Street,  
Sowcarpet Chennai,  
Tamil Nadu-600079 (INDIA)

### KERALA

BIOCON ELECTRIC PRIVATE LIMITED  
CALICUT / COCHIN

### JAMMU

BIOCON ELECTRIC PRIVATE LIMITED  
Jammu

### TELANGANA

BIOCON ELECTRIC PRIVATE LIMITED  
HYDERABAD

### ASSAM

BIOCON ELECTRIC PRIVATE LIMITED  
GUWAHATI

### NETWORKS

#### OFFICES | SHOWROOMS | DISPLAY CENTRE

KARNATAKA, TAMIL NADU, TELANGANA, ANDHRA PRADESH, KERALA,  
RAJASTHAN, GUJARAT, MADHYA PRADESH, CHHATTISGARH, H.P, U.K,  
MAHARASHTRA, PUNJAB, HARYANA, U.P, BIHAR, JAMMU AND KASHMIR,  
WEST BENGAL, ODISHA, JHARKHAND, NORTH EAST.



[www.bioconelectric.com](http://www.bioconelectric.com)

Email : [Info@bioconelectric.in](mailto:Info@bioconelectric.in)

Toll Free No. : 1800-120-555 444

